

feltdecor<sup>®</sup>  
s.line

---

More than silent

**SilentScape**  
Modular ceiling baffles

[www.feltdecor.eu](http://www.feltdecor.eu)

# SilentScape



## SilentScape - Your Contemporary Acoustic Atmosphere

Transform your space into a unique oasis of harmony and tranquility. The SilentScape collection combines aesthetics, functionality, and exceptional acoustic properties, providing an environment conducive to concentration, communication, and relaxation.

### Quiet Elegance

SilentScape is synonymous with elegance. The ceiling modules in this collection have been designed with modern interior decor in mind, maintaining a minimalist appearance while offering a variety of colors to match any interior.

### Incredible Acoustics

The main advantage of the SilentScape collection lies in the professional acoustic materials used, which not only look beautiful but also enhance sound quality in the room.

### Modular Flexibility

SilentScape offers unlimited design flexibility. Modules can be connected and arranged in any way, allowing for the creation of unique patterns and configurations. Regardless of the room size, SilentScape is a solution that meets your needs.



## SilentLink

**Composition:** 100% poliester (up to 92% recycled)

**Edge:** straight

**Dimension:** 1200 x 1200 mm

**Thickness:** 9 mm

**Density:** 1900 g/m<sup>2</sup>

**Sound absorption class:** PN-EN PN-EN ISO11654  $\alpha_w = 0,85$  Class B

**Fire classification:** B-s2, d0 non-flammable (ITB report of the installed product)

**Color scheme:** According to the S-line color chart

**Mounting method:** Screwed into the ceiling or suspended on cables.

# SilentLink

SilentLink\_120  
1200 x 1200 x 210 mm

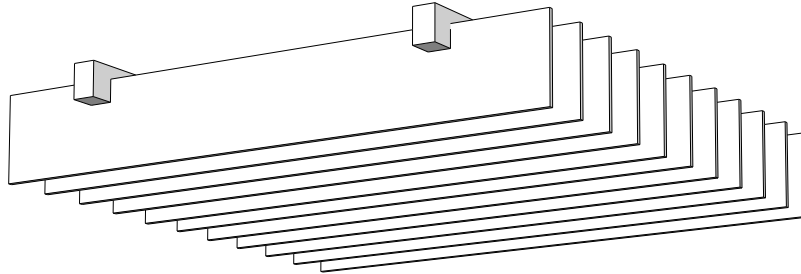

## Two mounting systems to choose from:

### Wide mounting rail - 2 pcs

\*mount - directly to the ceiling/wall or suspend with cables.\*

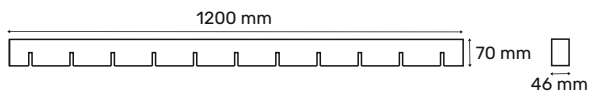

### Narrow mounting rail - 2 pcs

\*mount - suspension with cables\*

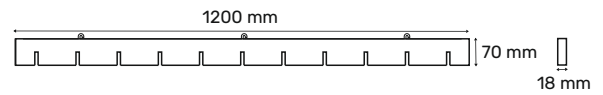

## Baffle - 11 pcs

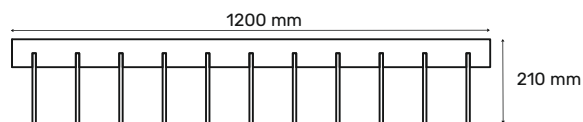
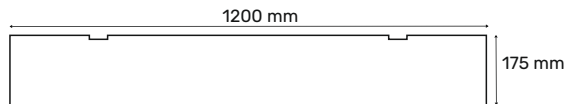

### Wide mounting rail

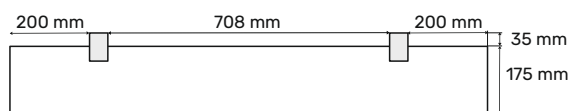

### Narrow mounting rail

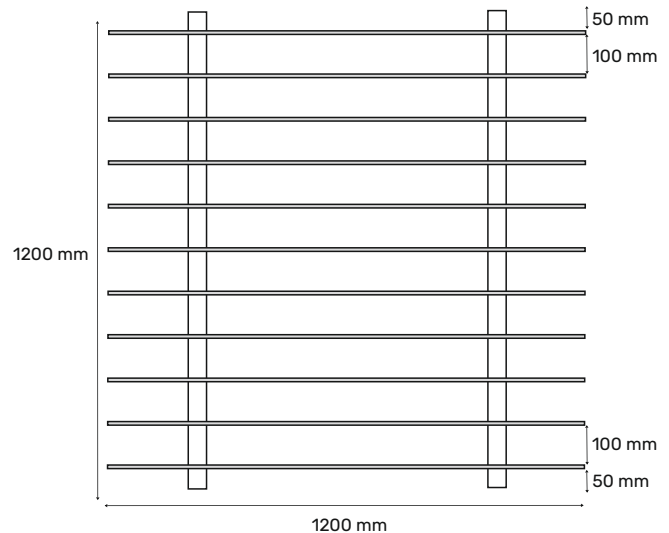
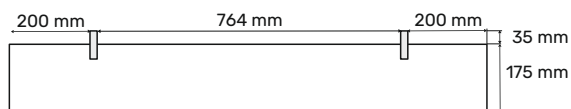



## WhisperWave

**Composition:** 100% poliester (up to 92% recycled)

**Edge:** straight

**Dimension:** 1200 x 1200 mm

**Thickness:** 9 mm

**Density:** 1900 g/m<sup>2</sup>

**Sound absorption class:** PN-EN PN-EN ISO11654  $\alpha_w = 0,85$  Class B

**Fire classification:** B-s2, d0 non-flammable (ITB report of the installed product)

**Color scheme:** According to the S-line color chart

**Mounting method:** Screwed into the ceiling or suspended on cables.

# WhisperWave

**WhisperWave\_120**  
1200 x 1200 x 210 mm

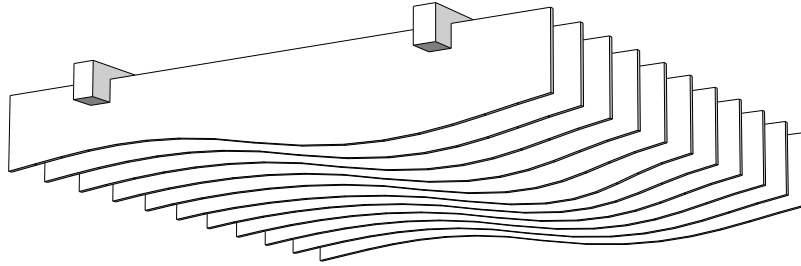

**Two mounting systems to choose from:**

**Wide mounting rail - 2 pcs**

\*mount - directly to the ceiling/wall or suspend with cables.\*

**Narrow mounting rail -2 pcs**

\*mount - suspension with cables

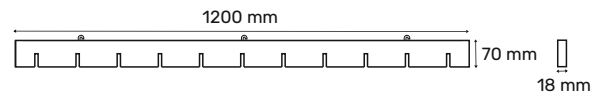
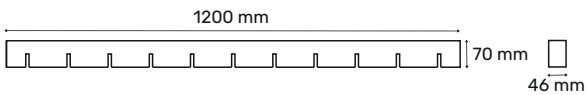

**Baffle - 11 pcs**

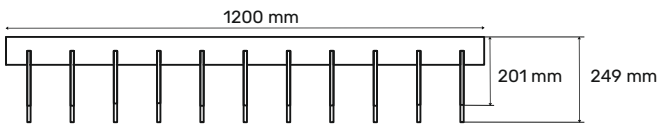
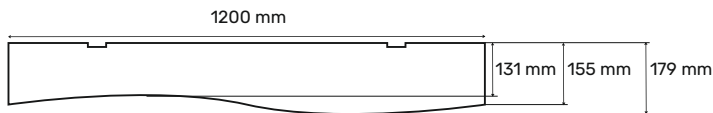

**Wide mounting rail**

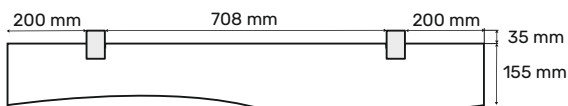

**Narrow mounting rail**

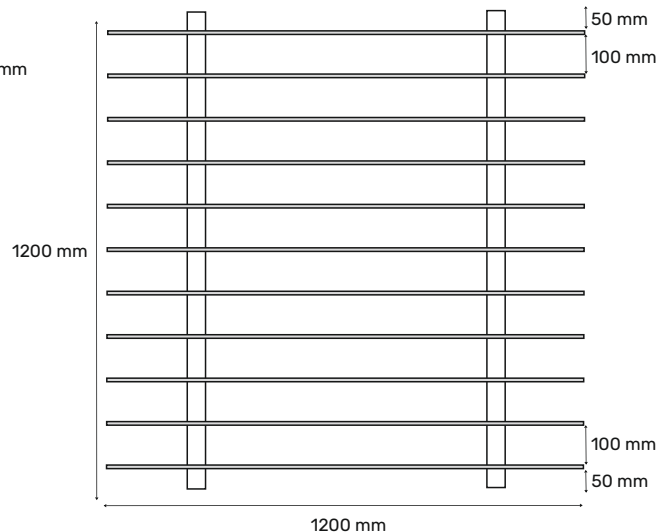
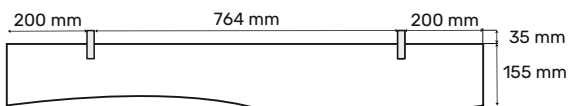



## FlexiTone

**Composition:** 100% poliester (up to 92% recycled)

**Edge:** straight

**Dimension:** 1200 x 1200 mm

**Thickness:** 9 mm

**Density:** 1900 g/m<sup>2</sup>

**Sound absorption class:** PN-EN PN-EN ISO11654  $\alpha_w = 0,85$  Class B

**Fire classification:** B-s2, d0 non-flammable (ITB report of the installed product)

**Color scheme:** According to the S-line color chart

**Mounting method:** Screwed into the ceiling or suspended on cables.

# FlexiTone

**FlexiTone\_120**  
1200 x 1200 x 210 mm

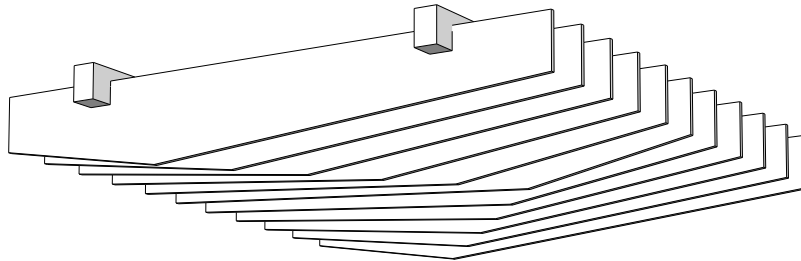

**Two mounting systems to choose from:**

**Wide mounting rail - 2 pcs**

\*mount - directly to the ceiling/wall or suspend with cables.\*

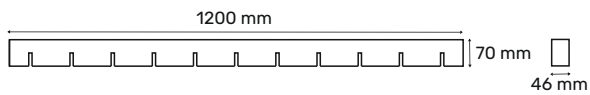

**Narrow mounting rail -2 pcs**

\*mount - suspension with cables

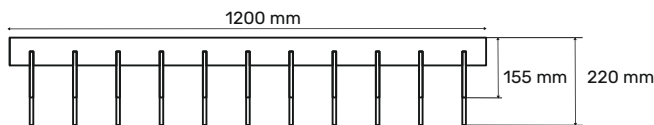
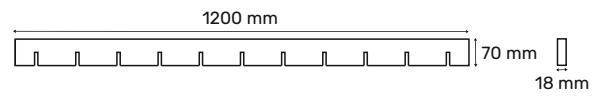

**Wide mounting rail**

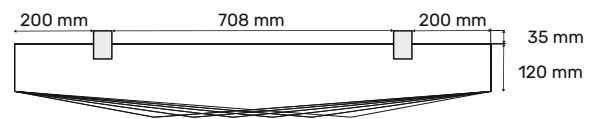

**Narrow mounting rail**

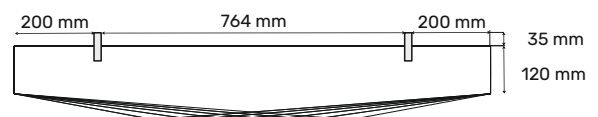

**Baffle - 11 pcs**

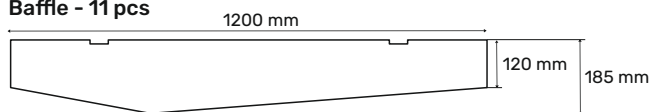

**The order of attaching the lower elements.**

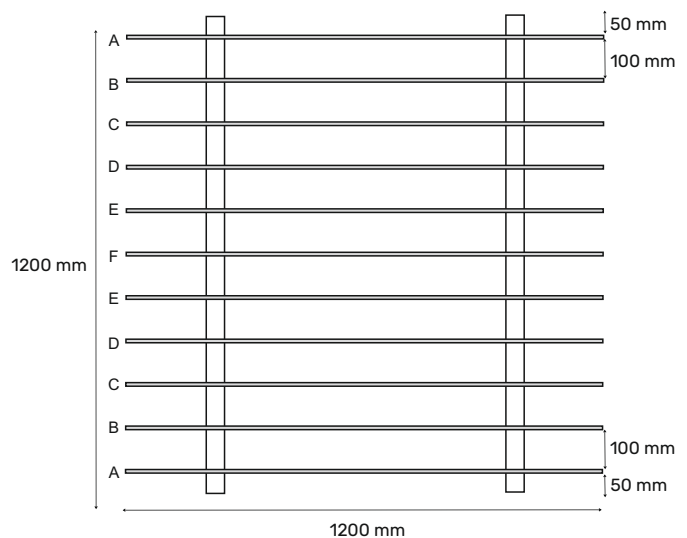
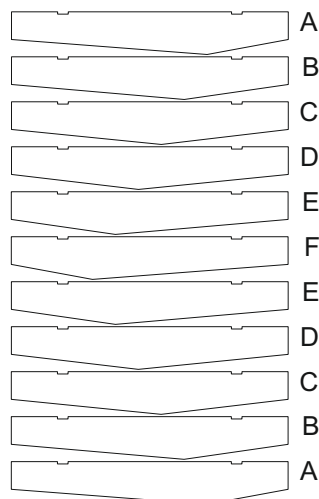





## HarmonyGrid

**Composition:** 100% poliester (up to 92% recycled)

**Edge:** straight

**Dimension:** 1200 x 1200 mm

**Thickness:** 9 mm

**Density:** 1900 g/m<sup>2</sup>

**Sound absorption class:** PN-EN PN-EN ISO11654  $\alpha_w = 0,85$  Class B

**Fire classification:** B-s2, d0 non-flammable (ITB report of the installed product)

**Color scheme:** According to the S-line color chart

**Mounting method:** Screwed into the ceiling or suspended on cables.

# HarmonyGrid

**HarmonyGrid\_120**  
1200 x 1200 x 135 mm

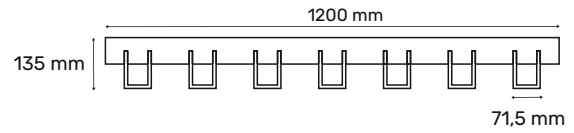
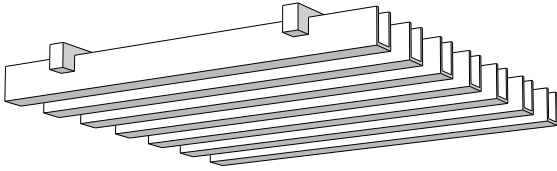

**HarmonyGrid\_120-F**  
1200 x 1200 x 135 mm

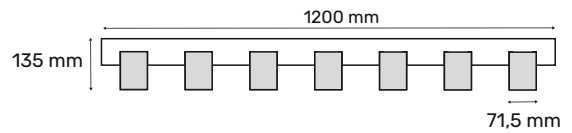
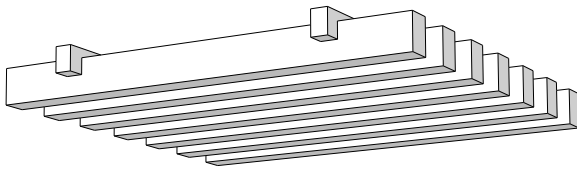

**Two mounting systems to choose from:**

**Wide mounting rail - 2 pcs**

\*mount - directly to the ceiling/wall or suspend with cables.\*

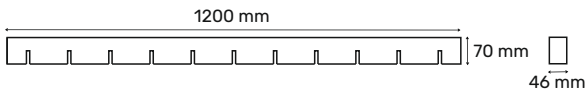

**Narrow mounting rail -2 pcs**

\*mount - suspension with cables

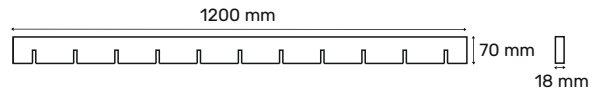

**HarmonyGrid**

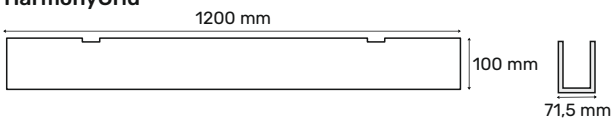

**HarmonyGrid\_F**

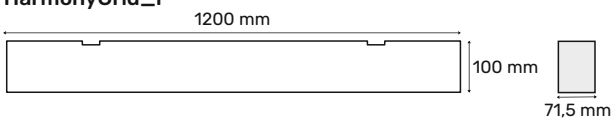

**Wide mounting rail**

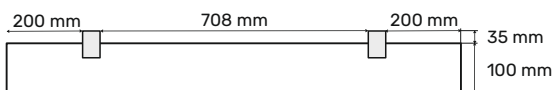

**Narrow mounting rail**

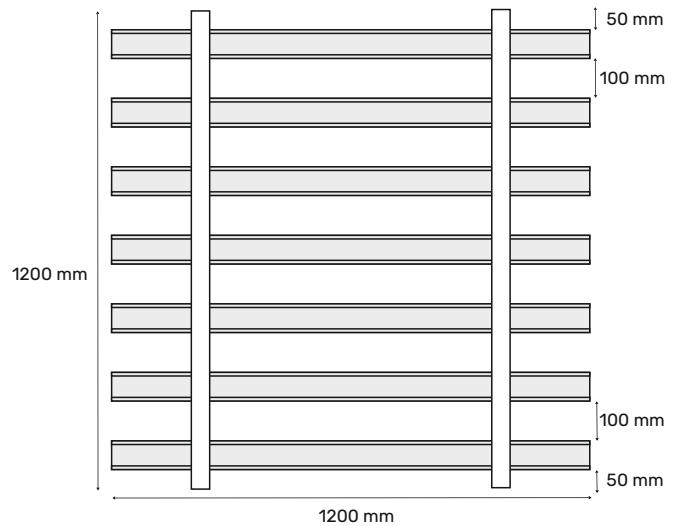
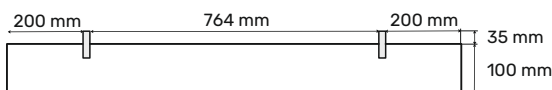



## SilentTune

**Composition:** 100% poliester (up to 92% recycled)

**Edge:** straight

**Dimension:** 1200 x 1200 mm

**Thickness:** 9 mm

**Density:** 1900 g/m<sup>2</sup>

**Sound absorption class:** PN-EN PN-EN ISO11654  $\alpha_w = 0,85$  Class B

**Fire classification:** B-s2, d0 non-flammable (ITB report of the installed product)

**Color scheme:** According to the S-line color chart

**Mounting method:** Screwed into the ceiling or suspended on cables.

# SilentTune

**SilentTune\_120**  
1200 x 1200 x 210 mm

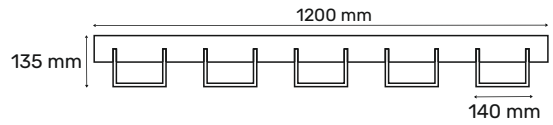
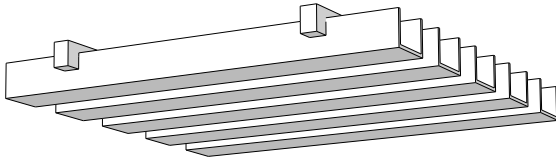

**SilentTune\_120-F**  
1200 x 1200 x 210 mm

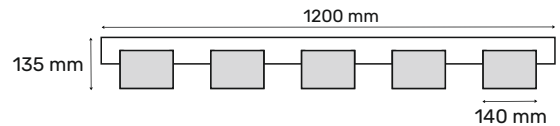
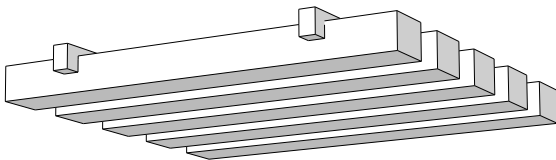

**Two mounting systems to choose from:**

**Wide mounting rail - 2 pcs**

\*mount - directly to the ceiling/wall or suspend with cables.\*

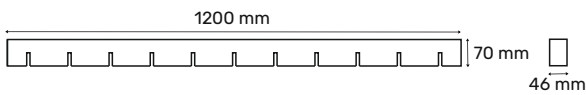

**Narrow mounting rail - 2 pcs**

\*mount - suspension with cables

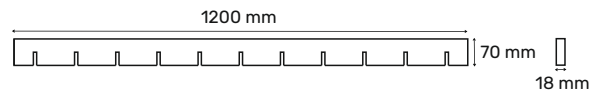

**SilentTune**

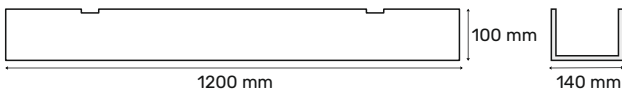

**SilentTune\_F**

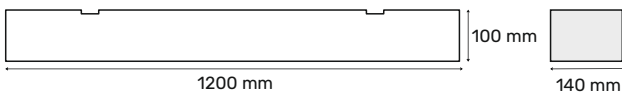

**Wide mounting rail**

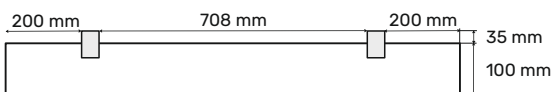

**Narrow mounting rail**

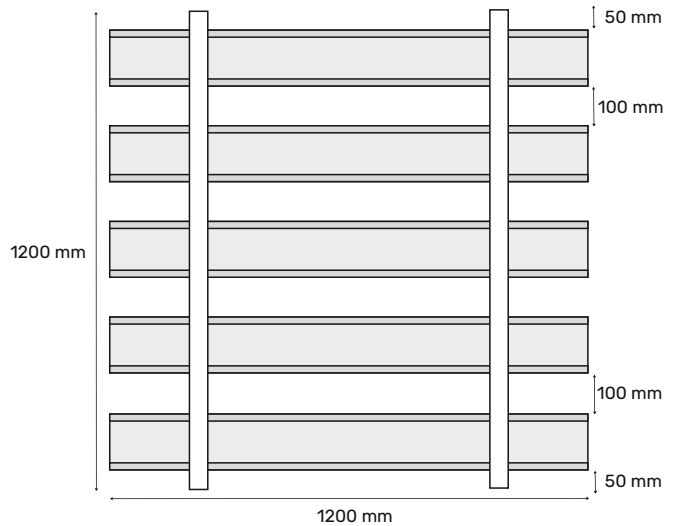
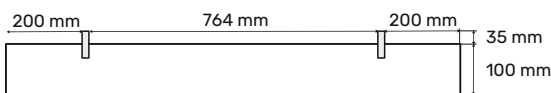

# color chart



WOLF GREY

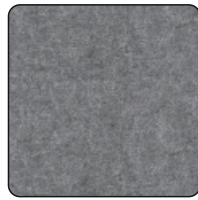

ASH GREY

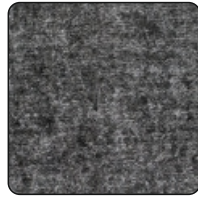

MOONSTONE GREY



RAVEN BLACK

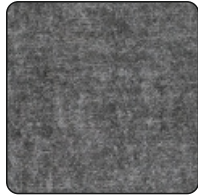

ONYX GREY



FALLOW GREY



DESERT SAND



SANDY BEIGE



BURLY WOOD



UMBER BROWN



PERU BROWN



SUNNY YELLOW

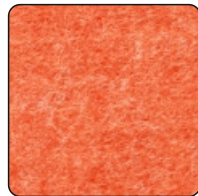

TANGERINE

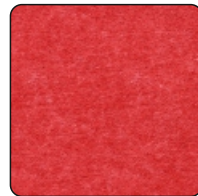

POPPY RED

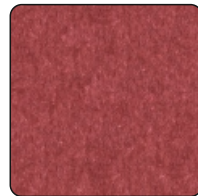

CRIMSON MIST



PURPLE RAIN



GALACTIC INDIGO



DEEP SKY BLUE



AZURE BLUE

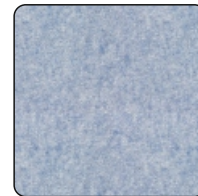

SPRING SKY



EMERALD AURORA



PERIDOT GREEN



SPRING GREEN



FRESH GRASS

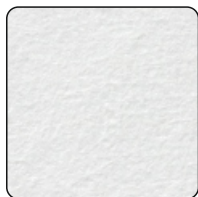

MOONLIGHT

More than silent

\* Colors on the color chart, while selected to be as close as possible to the original color shades, may vary depending on screen settings. To ensure your choice, we recommend viewing samples at the distributor's location.

# price list

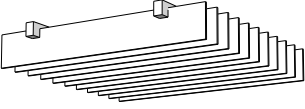
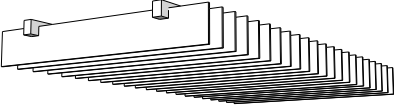
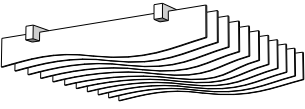
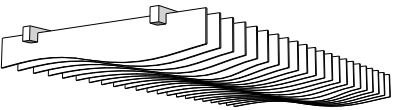
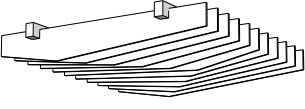
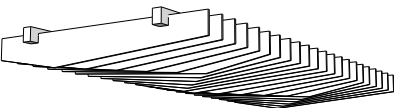
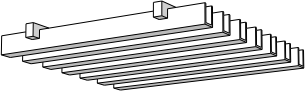
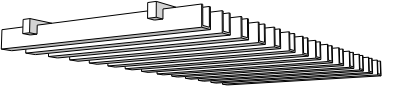
Product	Dimensions H x W	net price/pcs
<b>SilentLink_120</b> 	1200 x 1200 mm	€ 418,00
<b>SilentLink_240</b> 	2400 x 1200 mm	€ 836,00
<b>WhisperWave_120</b> 	1200 x 1200 mm	€ 441,00
<b>WhisperWave_240</b> 	2400 x 1200 mm	€ 881,00
<b>FlexiTone_120</b> 	1200 x 1200 mm	€ 441,00
<b>FlexiTone_240</b> 	2400 x 1200 mm	€ 881,00
<b>HarmonyGrid_120</b> 	1200 x 1200 mm	€ 500,00
<b>HarmonyGrid_240</b> 	2400 x 1200 mm	€ 1018,00

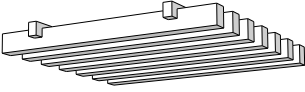
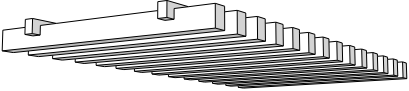
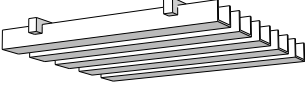
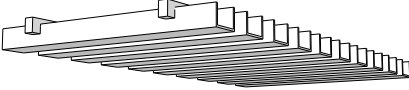
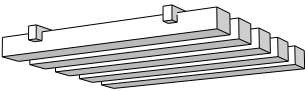
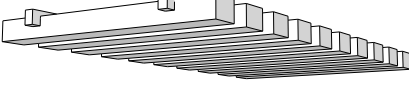
Product	Dimensions H x W	net price/pcs
<b>HarmonyGrid_120-F</b> 	1200 x 1200 mm	€ 524,00
<b>HarmonyGrid_240-F</b> 	2400 x 1200 mm	€ 1024,00
<b>SilentTune_120</b> 	1200 x 1200 mm	€ 456,00
<b>SilentTune_240</b> 	2400 x 1200 mm	€ 912,00
<b>SilentTune_120-F</b> 	1200 x 1200 mm	€ 490,00
<b>SilentTune_240-F</b> 	2400 x 1200 mm	€ 946,00
Grip system (4 pce.)		€ 36,00
UV Print (printing the entire ceiling, e.g. with a wood or concrete texture)		€ 145,00

price list valid from od 01/ 02/2024/4,5

## Shipping

The individual packaging size depends on the ceiling model.  
The estimated weight of the kit is around 10 kg.  
Shipping costs are calculated on an individual basis.

---

## Lead time

14-30 business days depending on material availability.  
Please inquire with the distributor about material and color availability.  
The list of distributors can be found at <https://feltdecor.eu/gdzie-kupic/>





**Assembly - wide rail**  
**Suspension with cables**  
**Method #1**

1. Mount 4 pieces of mounting hangers in the previously prepared holes in the ceiling.

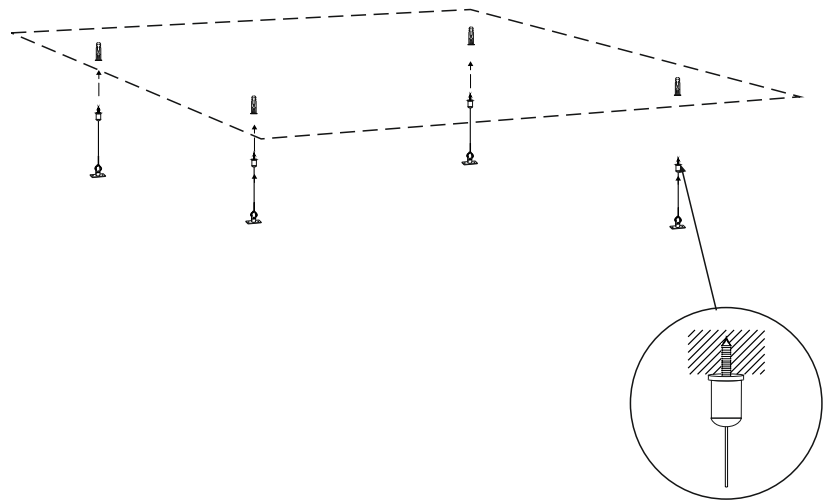

2. Screw the rail to the lower brackets of the hangers. Adjust the suspension height using the cable.

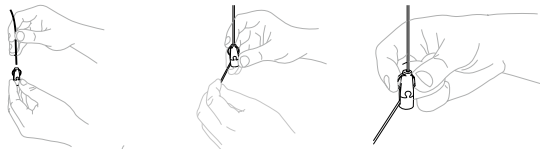
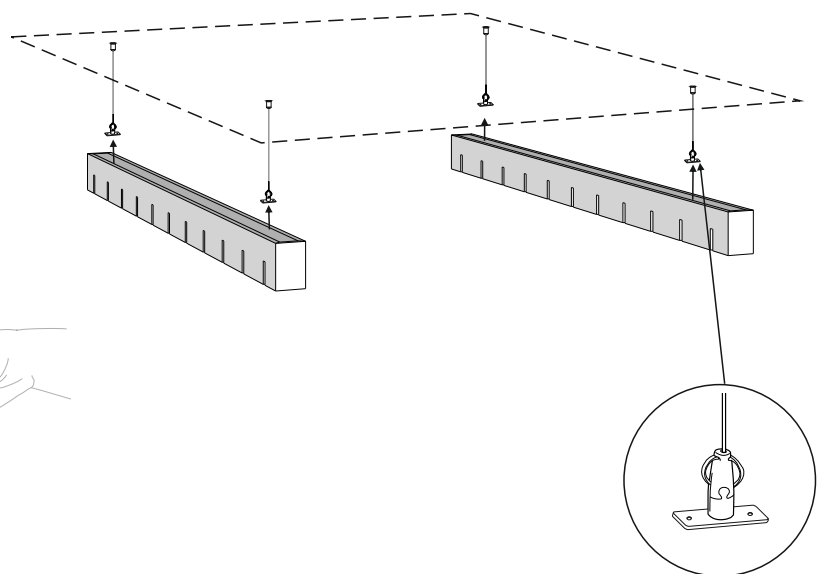

3. Insert the lower elements of the ceiling into the slots located in the rail.

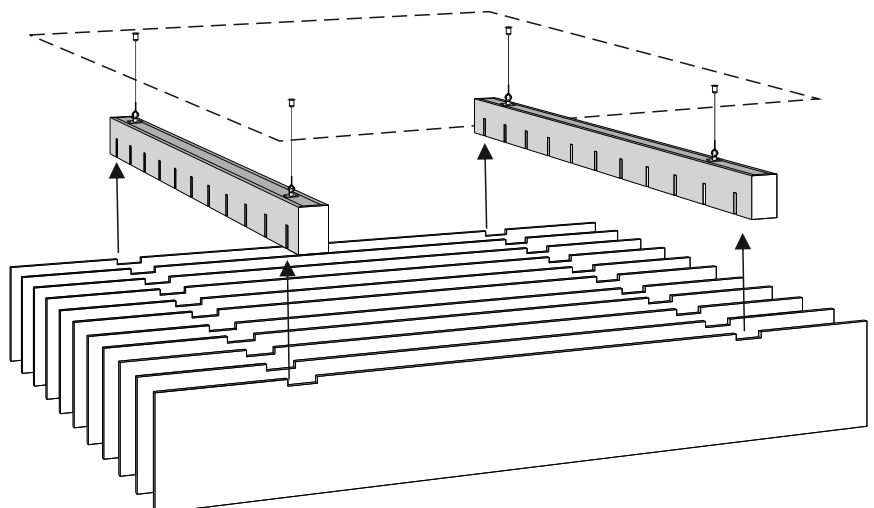

**Assembly - wide rail**  
**Suspension with cables**  
**Method #2**

1. Prepare holes in the ceiling.

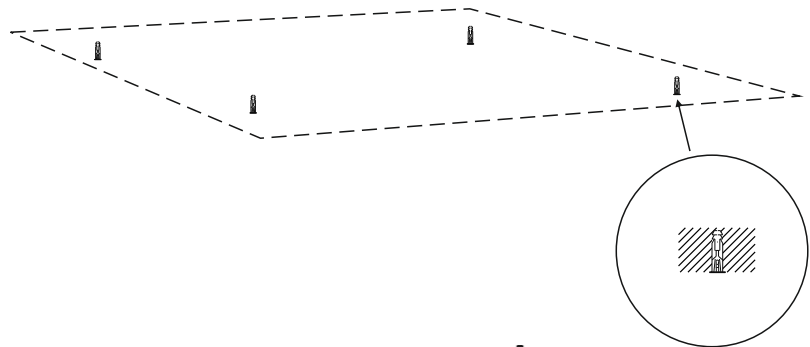

2. Screw the lower brackets of the mounting hangers into the rail.

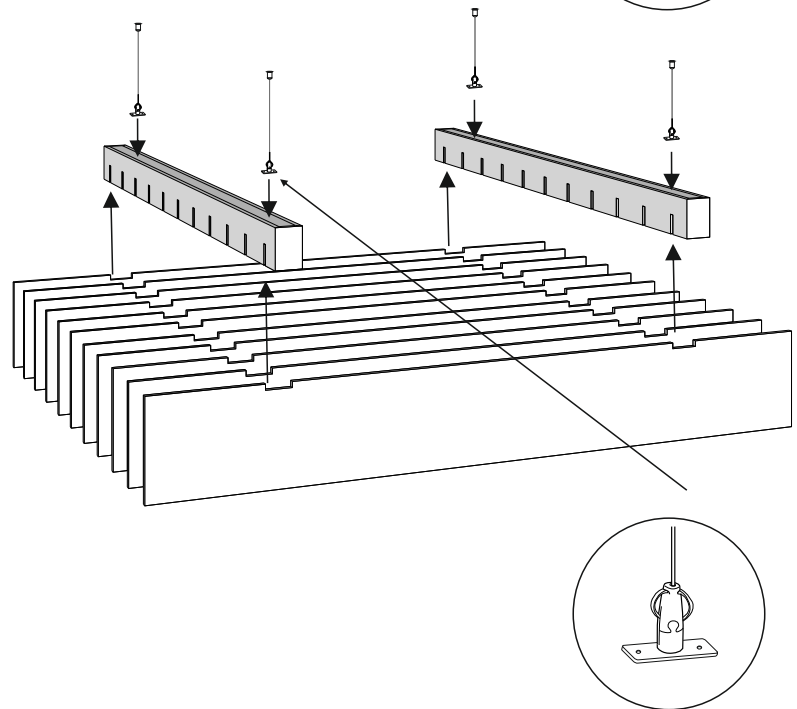

3. Insert the lower ceiling elements into the slots located in the rail.

4. Mount the pre-assembled module in the previously prepared holes in the ceiling.

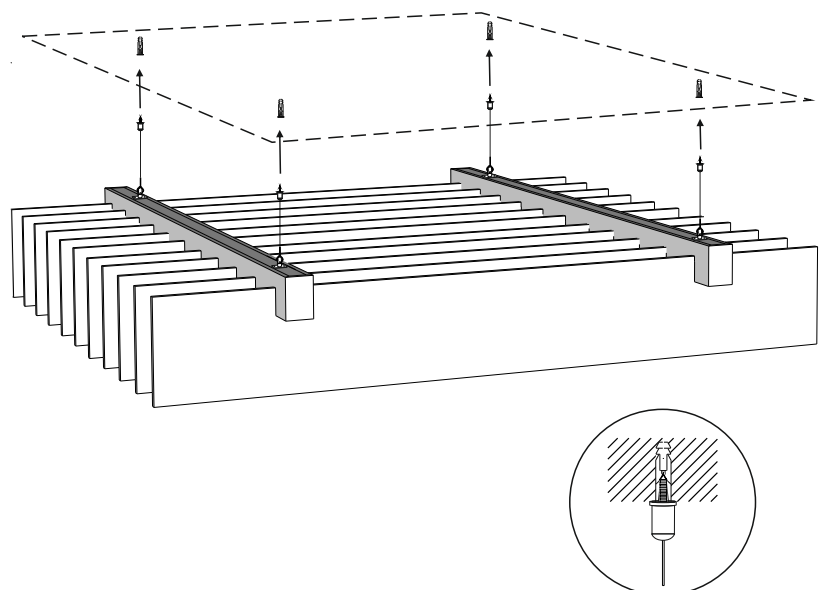

Adjust the suspension height using a cable.

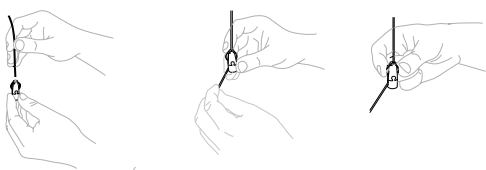

## Installation - screwing directly into the ceiling

1. Screw the rail into the prepared holes in the ceiling or wall.

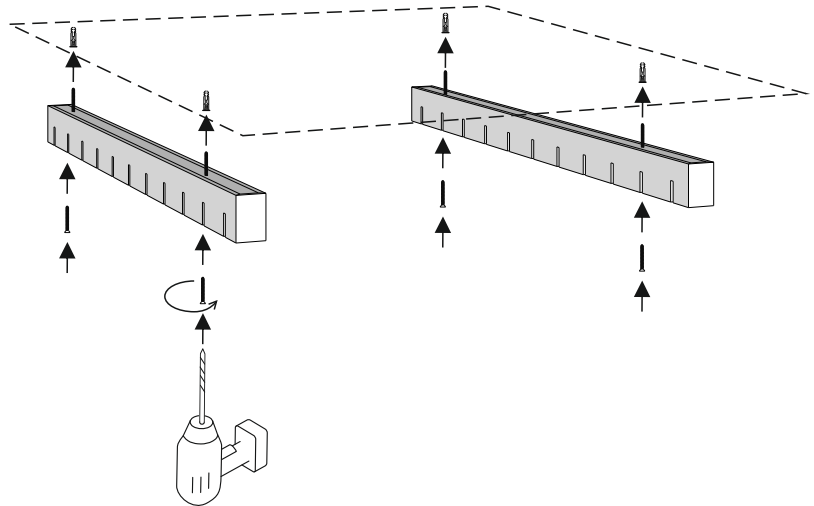

2. Insert the lower elements of the ceiling into the slots located in the rail.

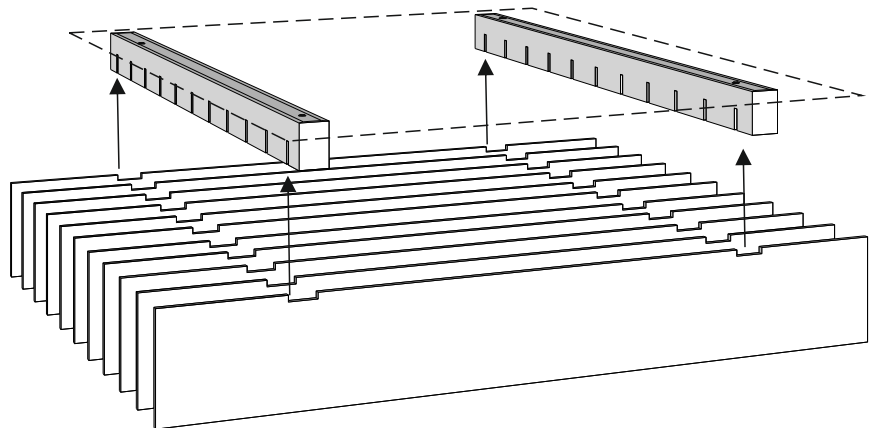

## Installation - suspension on cables with a narrow rail

1. Install 4 hooks into the previously prepared holes in the ceiling.

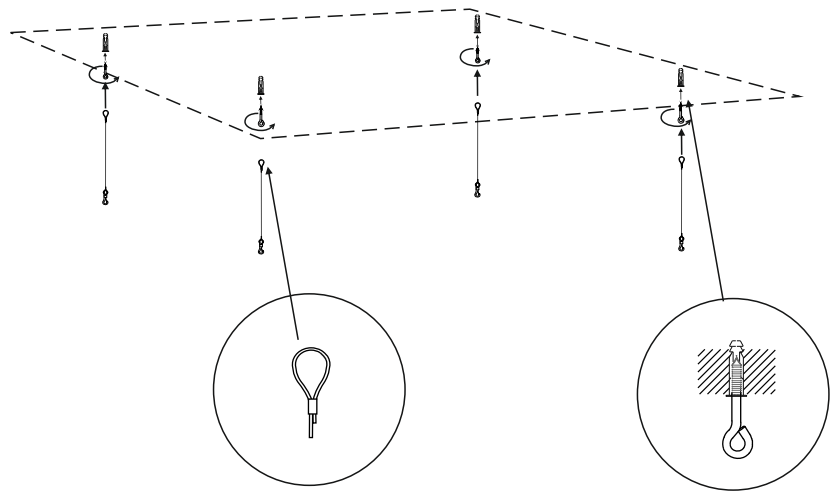
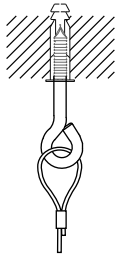

2. Hook the lower hanger brackets onto the hooks on the rail.  
Adjust the suspension height using the cable.

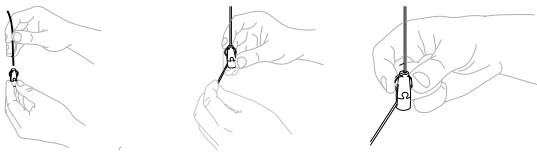
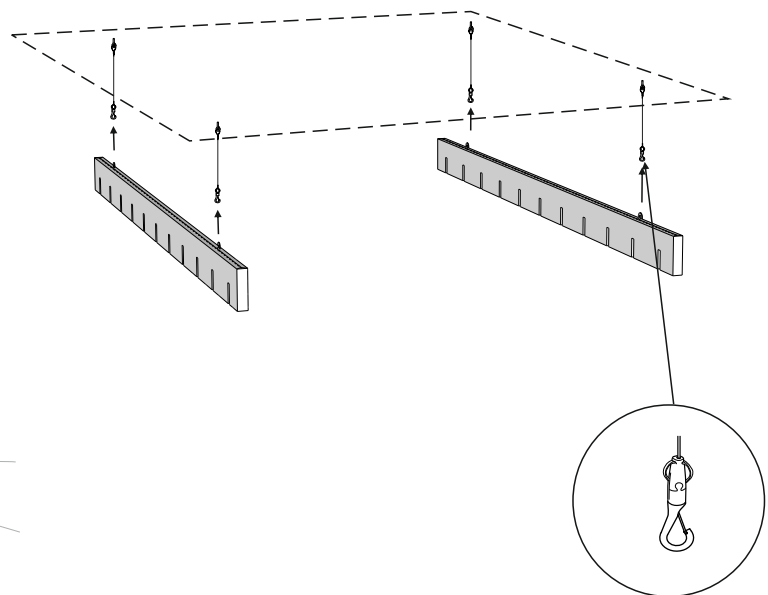
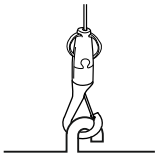

3. Insert the lower elements of the ceiling into the slots located in the rail.

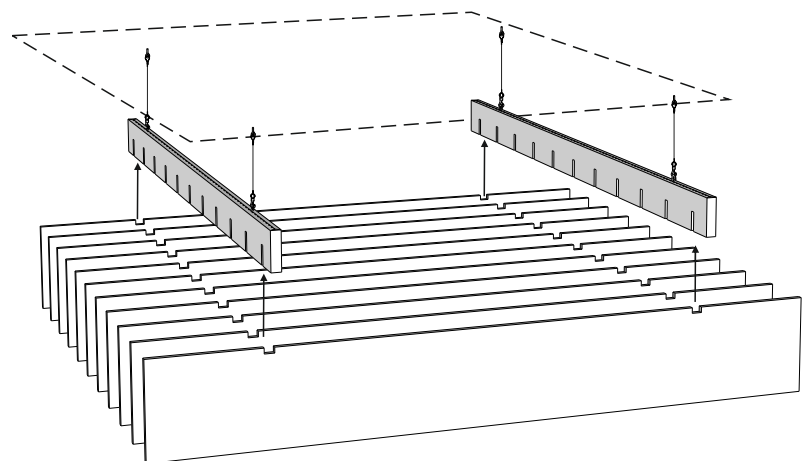

**Installation - narrow rail**  
**Suspension with cables**  
**Method #2**

1. Mount 4 hooks in the previously prepared holes in the ceiling.

Attach the upper loops of the suspension to the hooks.

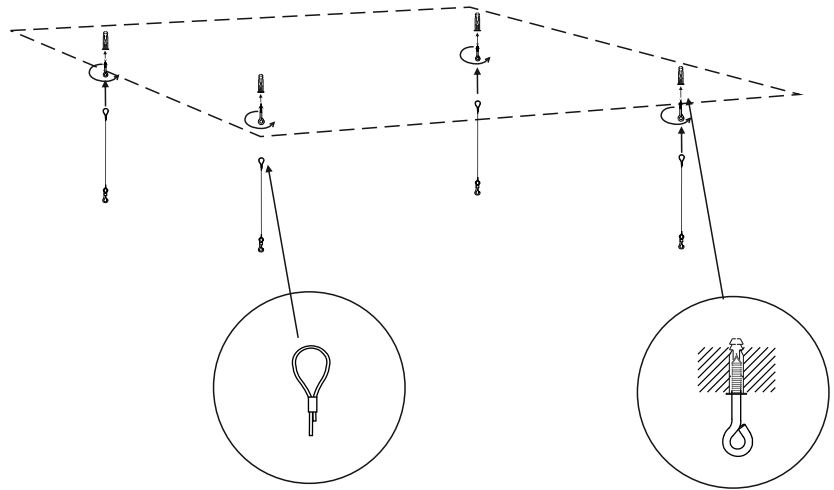
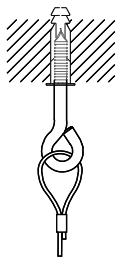

2. Insert the lower ceiling elements into the slots located in the rail.

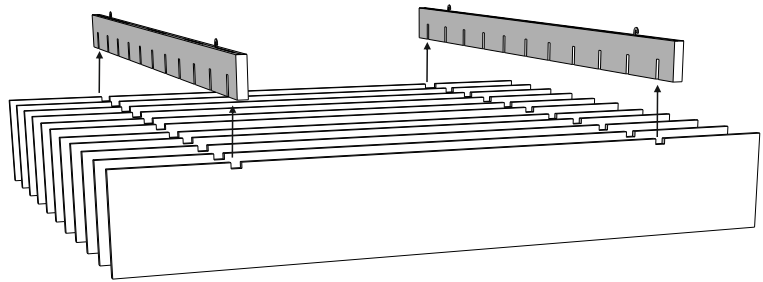

3. Mount the pre-assembled module by attaching the lower brackets of the suspension to the hooks on the rail.

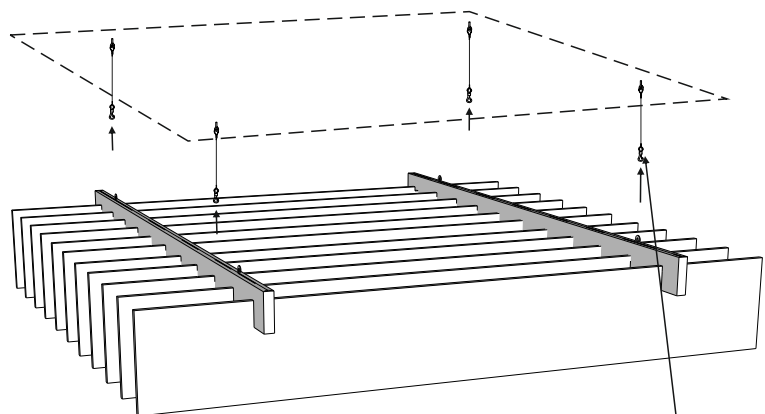
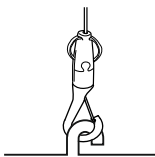

Adjust the suspension height using the cable.

