

feltdecor[®]
s.line

More than silent

TileFlex collection

www.feltdecor.eu

TILEFLEX



The TileFlex panels are designed to resemble the four cardinal directions, capturing the earthly perfection. With a wide range of colors and thoughtful design, they transform ordinary spaces into a realm of pure sound, where noise and echo become mere memories.

TileFlex panels open the door to an oasis of tranquility while creating a space full of elegance and style. Available in various shades and patterns, they allow for unique arrangements that add distinct personality to any interior. The captivating compositions on the walls will draw the attention of anyone who steps into such a room.

TileFlex is the epitome of modernity and minimalism, seamlessly blending with any interior. Their sleek design adds a touch of uniqueness, creating an atmosphere that enchants everyone. Whether for a home office, corporate setting, or exclusive hotel, these panels are a perfect fit. Their designer style, excellent acoustic properties, and incredibly easy installation have contributed to the growing popularity of our solutions.

RingCut



Composition K_RC01

Composition:	100% poliester (up to 92% recycled)
Cutting method:	V-cut at 22.5 degrees
Edge:	V-cut at 22.5 degrees
Dimension:	600 x 600 mm
Thickness:	9 mm
Density:	1900 g/m ²

The panel is available in 24 colors.









The color in the visualization:

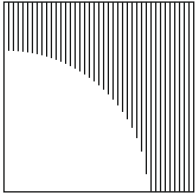

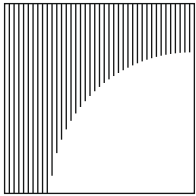

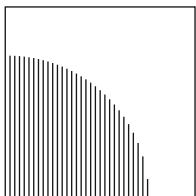

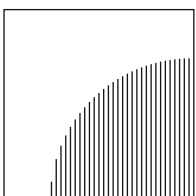

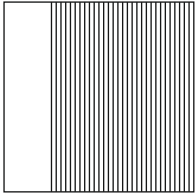

DESERT SAND

Sound absorption class:	PN-EN PN-EN ISO11654 $\alpha_w = 0,85$ Class B
Fire classification:	B-s2, d0 non-flammable (ITB report of the installed product)
Color scheme:	According to the S-line color chart
Mounting method:	Wall mounting - adhesive mounting
Minimum logistics:	8 panels
Unit packaging:	Cardboard box with dimensions 600 x 660 x 80 mm.

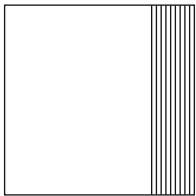
RingCut

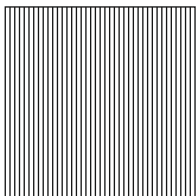
Panel	Dimensions HxWxD [mm]	Product code
 <p>Profile: </p>	600 x 600 x 9	FD60_RingL_SL01_L
 <p>Profile: </p>	600 x 600 x 9	FD60_RingL_SL02_R
 <p>Profile: </p>	600 x 600 x 9	FD60_RingL_SL03_FL
 <p>Profile: </p>	600 x 600 x 9	FD60_RingL_SL04_FR

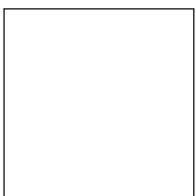
RingCut

Panel	Dimensions HxWxD [mm]	Product code
 <p>Profile: </p>	600 x 600 x 9	FD60_RingL_SL05_AF
 <p>Profile: </p>	600 x 600 x 9	FD60_RingL_SL06_AE
 <p>Profile: </p>	600 x 600 x 9	FD60_RingL_SL07_F
 <p>Profile: </p>	600 x 600 x 9	FD60_RingL_SL08_E

Sample compositions RingCut:

K_RC01

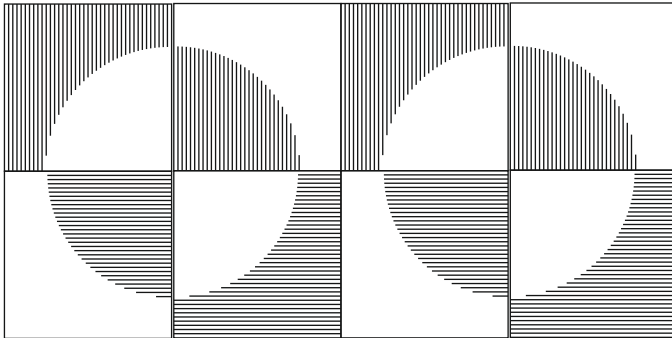

FD60_RingL_SL03_FL

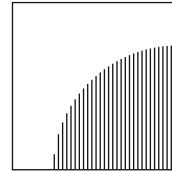

2 PIECES

FD60_BendL_SL04_FR

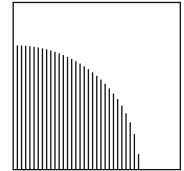

2 PIECES

FD60_RingL_SL01_L

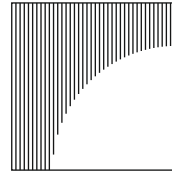

2 PIECES

FD60_RingL_SL02_R

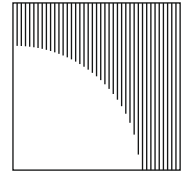

2 PIECES

K_RC02

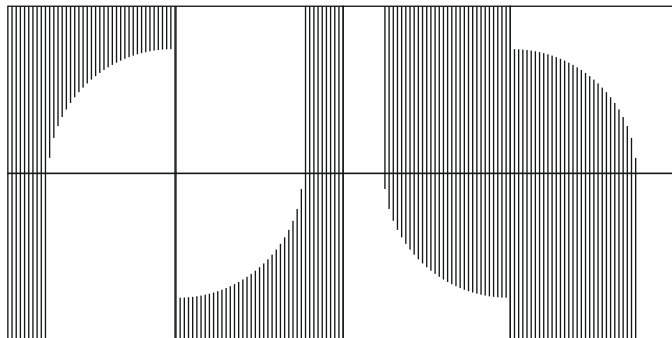

FD60_RingL_SL05_AF

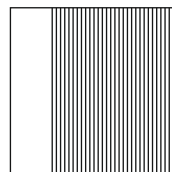

2 PIECES

FD60_RingL_SL06_AE

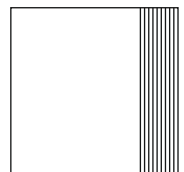

2 PIECES

FD60_RingL_SL01_L

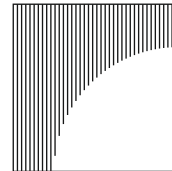

2 PIECES

FD60_BendL_SL04_FR

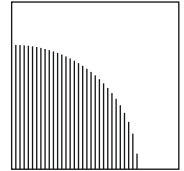

2 PIECES

K_RC03

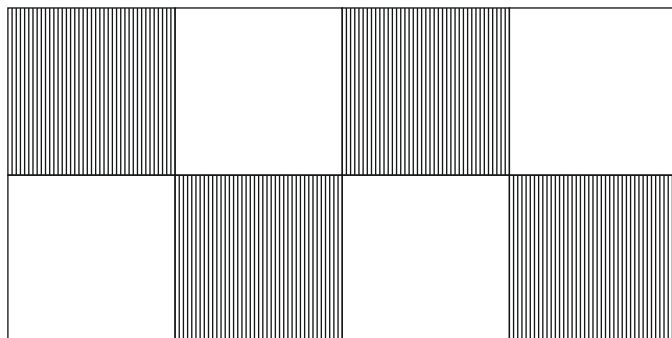

FD60_RingL_SL08_E

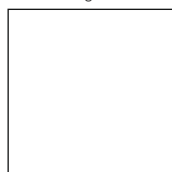

4 SZTUKI

FD60_RingL_SL07_F

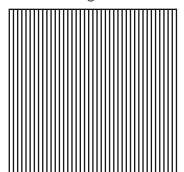

4 SZTUKI

Sample compositions **RingCut**:

K_RC04

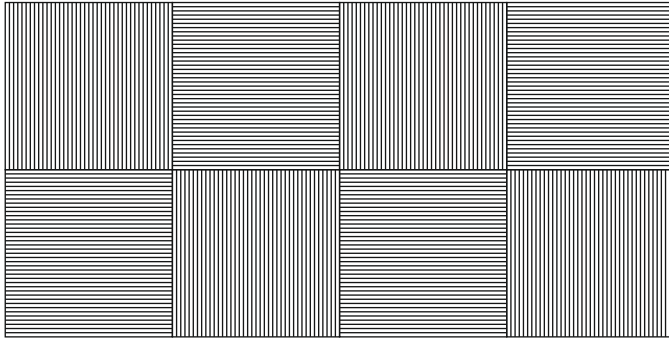

FD60_RingL_SL07_F

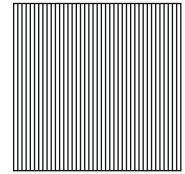

8 PIECES

K_RC05

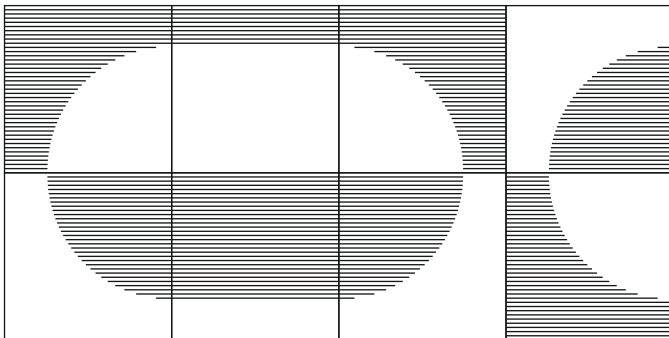

FD60_RingL_SL03_FL

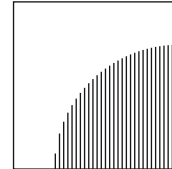

1 PIECE

FD60_BendL_SL04_FR

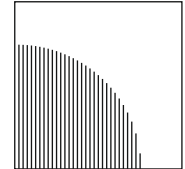

2 PIECES

FD60_RingL_SL01_L

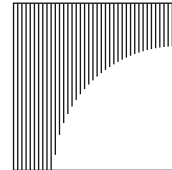

2 PIECES

FD60_RingL_SL02_R

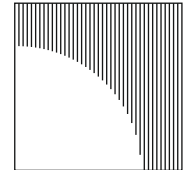

1 PIECE

FD60_RingL_SL05_AF

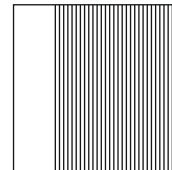

1 PIECE

FD60_RingL_SL06_AE

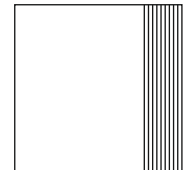

1 PIECE

K_RC06

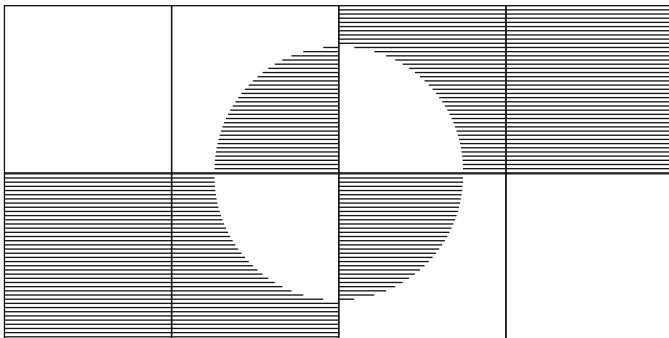

FD60_RingL_SL08_E

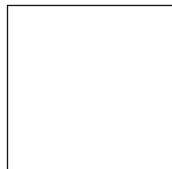

2 PIECES

FD60_RingL_SL07_F

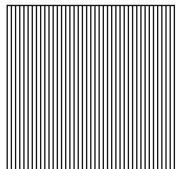

2 PIECES

FD60_RingL_SL01_L

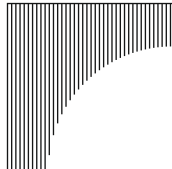

2 PIECES

FD60_RingL_SL04_FR

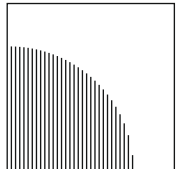

2 PIECES

Sample compositions **RingCut**:

K_RC07

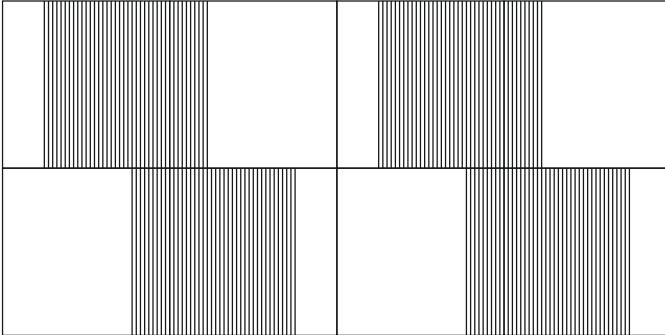

FD60_RingL_SL05_AF

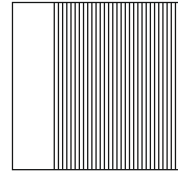

4 PIECES

FD60_RingL_SL06_AE

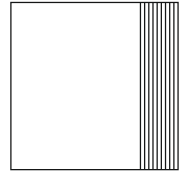

4 PIECES

K_RC08

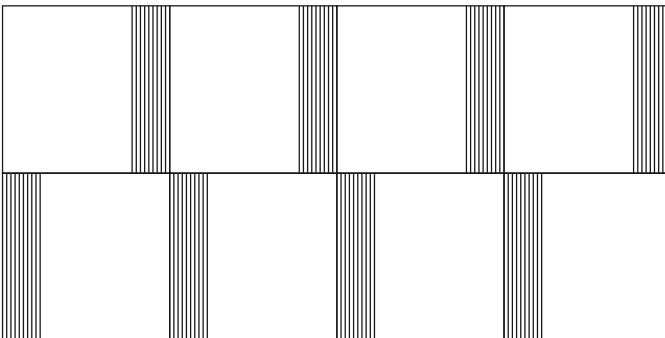

FD60_RingL_SL06_AE

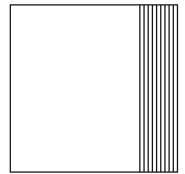

8 PIECES

K_RC09

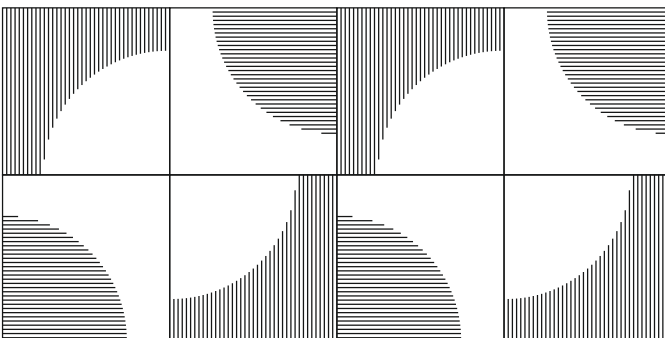

FD60_RingL_SL01_L

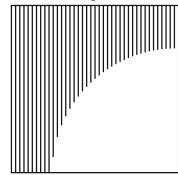

4 PIECES

FD60_RingL_SL03_FL

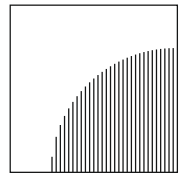

4 PIECES

SlantCut



Composition K_RS01

Composition:	100% poliester (up to 92% recycled)
Cutting method:	V-cut at 22.5 degrees
Edge:	V-cut at 22.5 degrees
Dimension:	600 x 600 mm
Thickness:	9 mm
Density:	1900 g/m ²

The panel is available in 24 colors.





The color in the visualization:

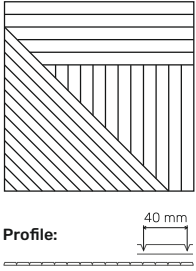

POPPY RED

Sound absorption class:	PN-EN PN-EN ISO11654 $\alpha_w = 0,85$ Class B
Fire classification:	B-s2, d0 non-flammable (ITB report of the installed product)
Color scheme:	According to the S-line color chart
Mounting method:	Wall mounting - adhesive mounting
Minimum logistics:	8 panels
Unit packaging:	Cardboard box with dimensions 600 x 660 x 80 mm.

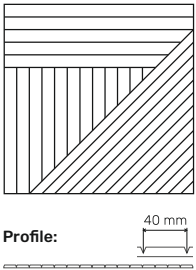
SlantCut

Panel	Dimensions HxWxD [mm]	Product code
 <p>Profile: </p>	600 x 600 x 9	FD60_SlantL_SL01_L
 <p>Profile: </p>	600 x 600 x 9	FD60_SlantL_SL02_R

Sample compositions **SlantCut**:

K_SC01

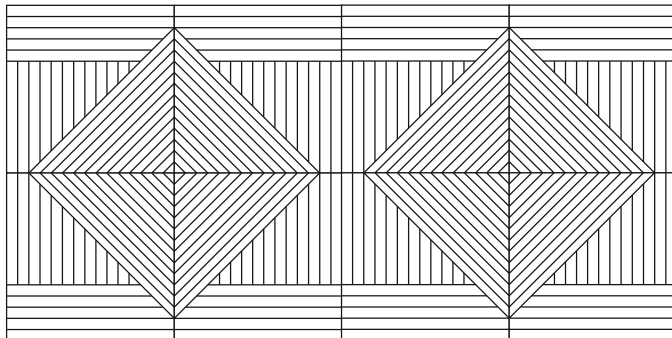

FD60_SlantL_SL02_R

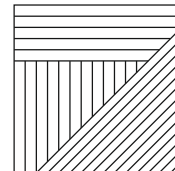

4 SZTUKI

FD60_SlantL_SL01_L

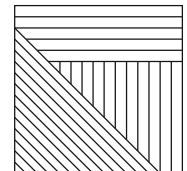

4 SZTUKI

Sample compositions **SlantCut**:

K_SC02

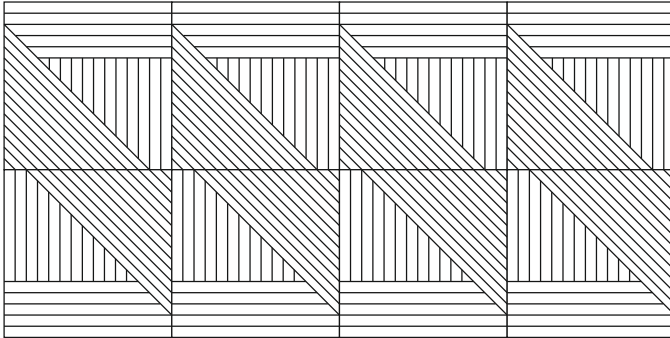

FD60_SlantL_SL01_L

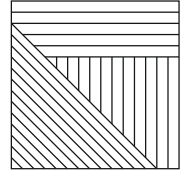

8 PIECES

K_SC03

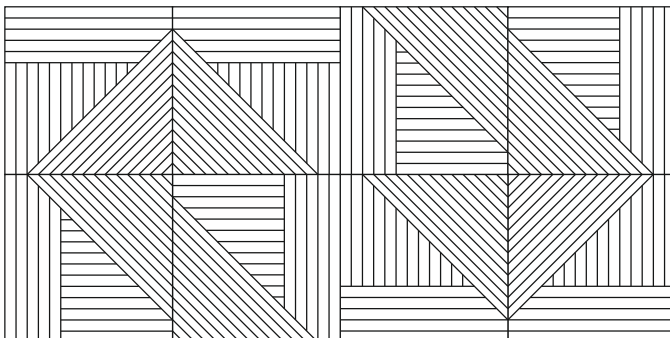

FD60_SlantL_SL02_R

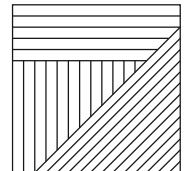

8 PIECES

K_SC04

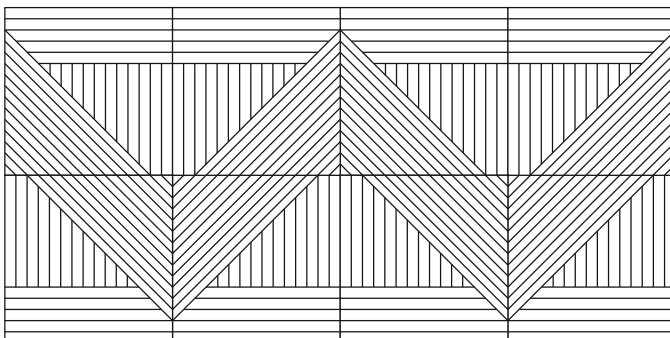

FD60_SlantL_SL02_R

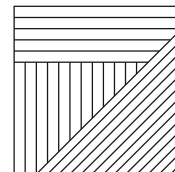

4 PIECES

FD60_SlantL_SL01_L

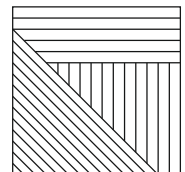

4 PIECES

Sample compositions **SlantCut**:

K_SL05

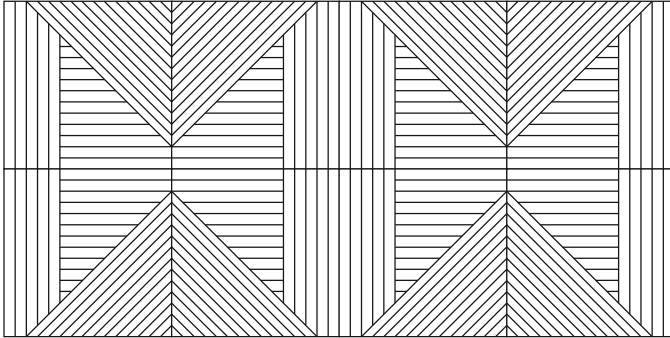

FD60_SlantL_SL02_R

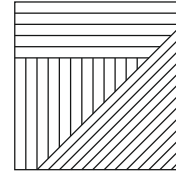

4 PIECES

FD60_SlantL_SL01_L

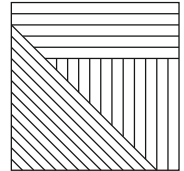

4 PIECES

K_SL06

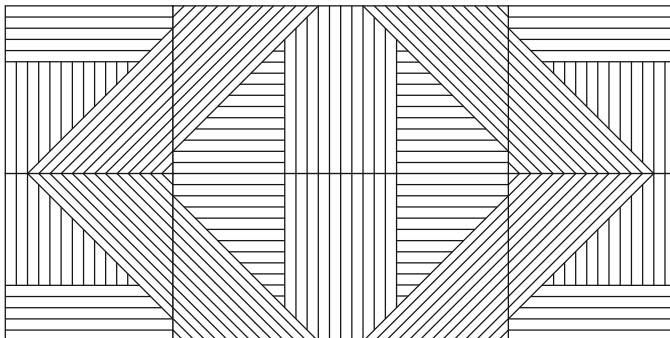

FD60_SlantL_SL02_R

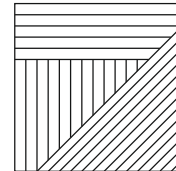

4 PIECES

FD60_SlantL_SL01_L

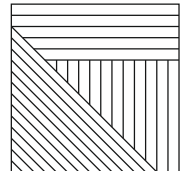

4 PIECES

K_SL07

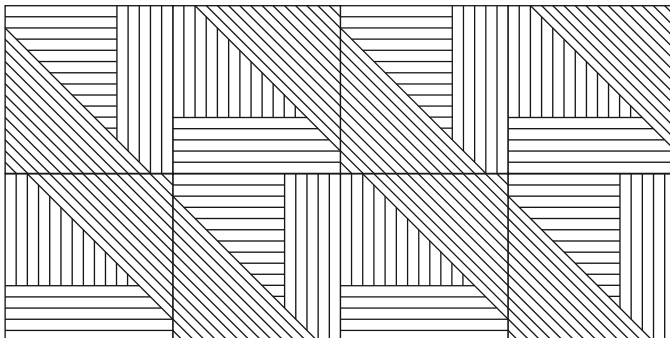

FD60_SlantL_SL02_R

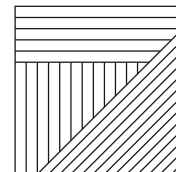

4 PIECES

FD60_SlantL_SL01_L

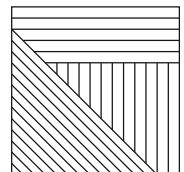

4 PIECES

CrossCut



Composition K_CC01

Composition:	100% poliester (up to 92% recycled)
Cutting method:	V-cut at 22.5 degrees
Edge:	V-cut at 22.5 degrees
Dimension:	600 x 600 mm
Thickness:	9 mm
Density:	1900 g/m ²

The panel is available in 24 colors.

The color in the visualization:



ONYX GREY

Sound absorption class:	PN-EN PN-EN ISO11654 $\alpha_w = 0,85$ Class B
Fire classification:	B-s2, d0 non-flammable (ITB report of the installed product)
Color scheme:	According to the S-line color chart
Mounting method:	Wall mounting - adhesive mounting
Minimum logistics:	8 panels
Unit packaging:	Cardboard box with dimensions 600 x 660 x 80 mm.

CrossCut

Panel	Dimensions HxWxD [mm]	Product code
 <p>Profile: </p>	600 x 600 x 9	FD60_CrossL_SL01_L
 <p>Profile: </p>	600 x 600 x 9	FD60_CrossL_SL02_R
 <p>Profile: </p>	600 x 600 x 9	FD60_CrossL_SL03_C
 <p>Profile: </p>	600 x 600 x 9	FD60_CrossL_SL04_F

Sample compositions **CrossCut:**

K_CC01

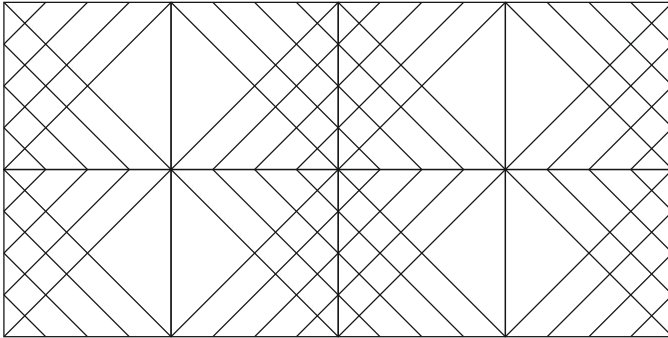

FD60_CrossL_SL03_C

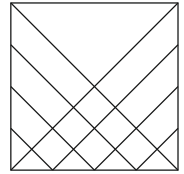

8 PIECES

K_CC02

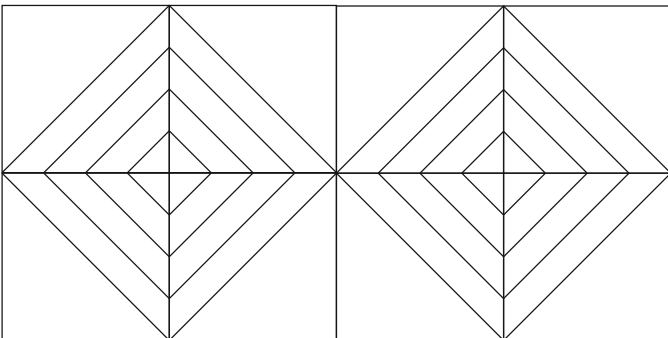

FD60_CrossL_SL01_L

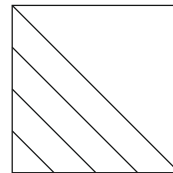

4 PIECES

FD60_CrossL_SL02_R

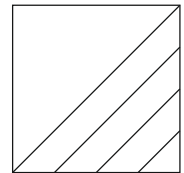

4 PIECES

K_CC03

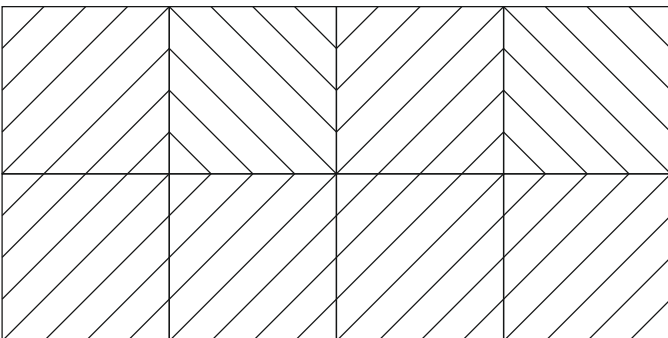

FD60_CrossL_SL04_F

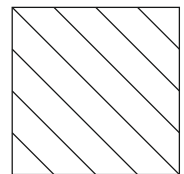

8 PIECES

Sample compositions **CrossCut:**

K_CC04

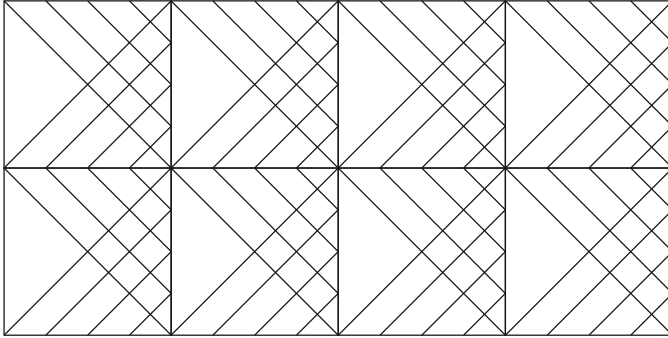

FD60_CrossL_SL03_C

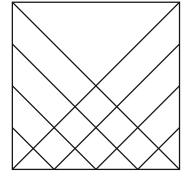

8 PIECES

K_CC05

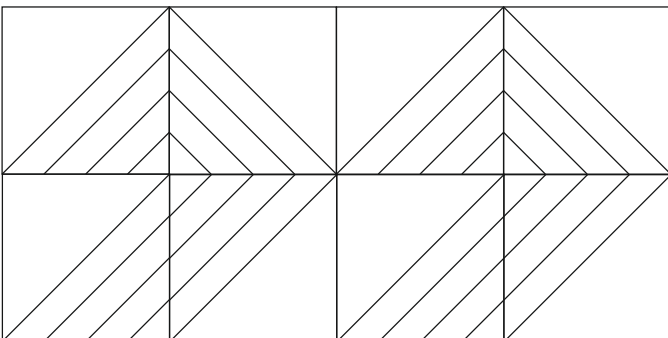

FD60_CrossL_SL01_L

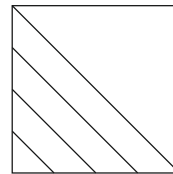

4 PIECES

FD60_CrossL_SL02_R

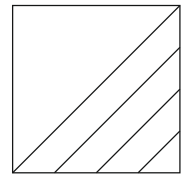

4 PIECES

K_CC06

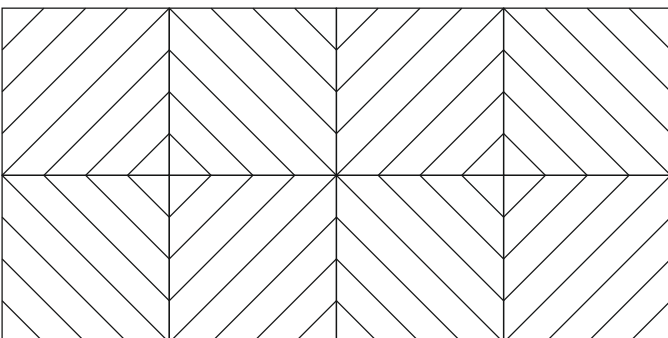

FD60_CrossL_SL04_F

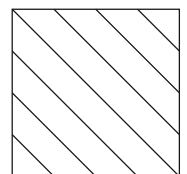

8 PIECES

Sample compositions **CrossCut**:

K_CC07

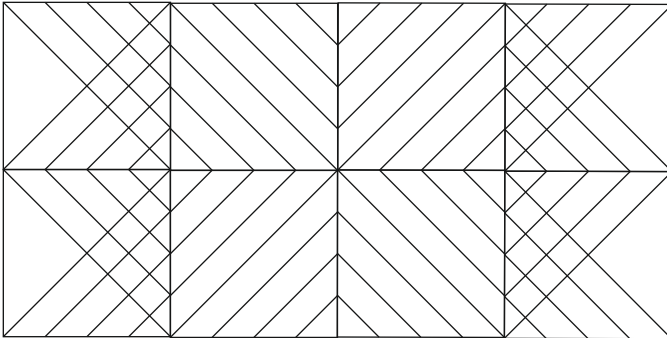

FD60_CrossL_SL04_F

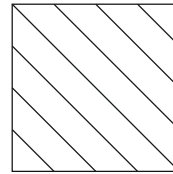

4 PIECES

FD60_CrossL_SL03_C

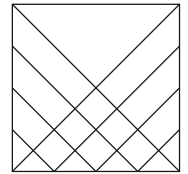

4 PIECES

K_CC08

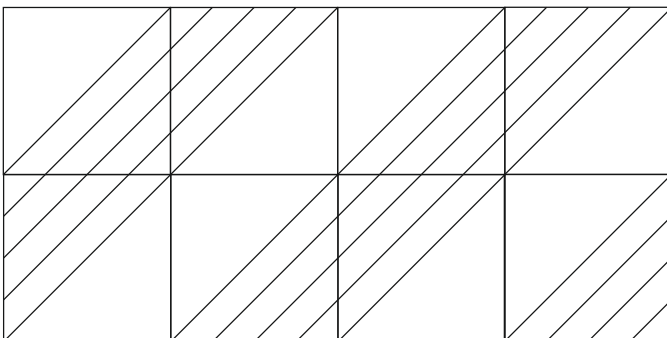

FD60_CrossL_SL01_L

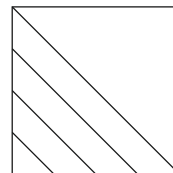

4 PIECES

FD60_CrossL_SL02_R

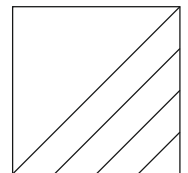

4 PIECES

K_CC09

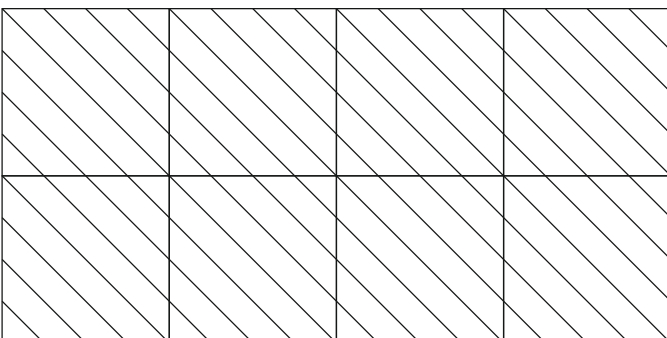

FD60_CrossL_SL04_F

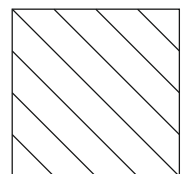

8 PIECES

Sample compositions **CrossCut**:

K_CC10

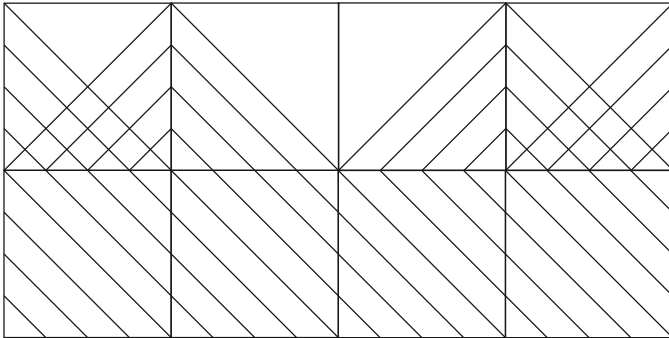

FD60_CrossL_SL01_L

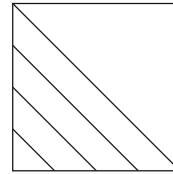

1 PIECES

FD60_CrossL_SL02_R

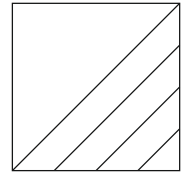

1 PIECES

FD60_CrossL_SL04_F

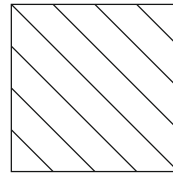

4 PIECES

FD60_CrossL_SL03_C

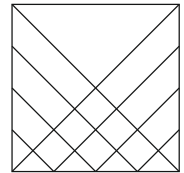

2 PIECES

K_CC11

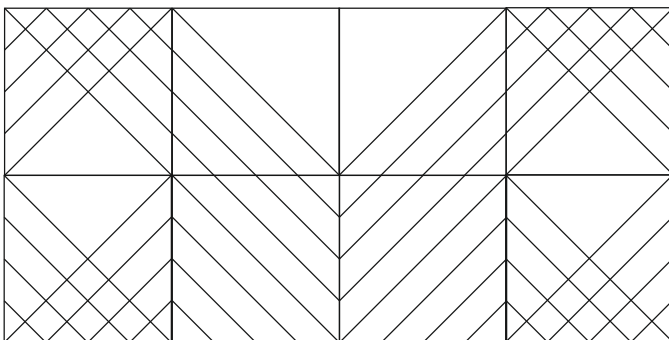

FD60_CrossL_SL01_L

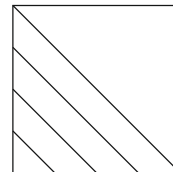

1 SZTUKA

FD60_CrossL_SL02_R

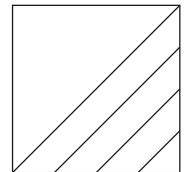

1 SZTUKA

FD60_CrossL_SL04_F

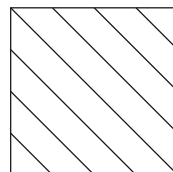

2 PIECES

FD60_CrossL_SL03_C

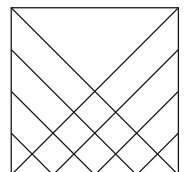

4 PIECES

K_CC12

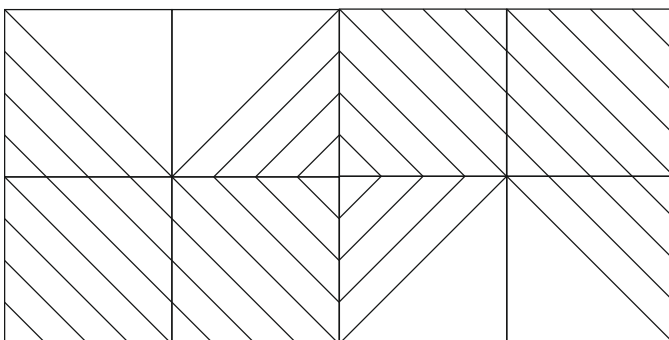

FD60_CrossL_SL01_L

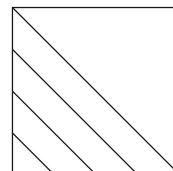

2 PIECES

FD60_CrossL_SL02_R

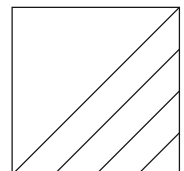

2 PIECES

FD60_CrossL_SL04_F

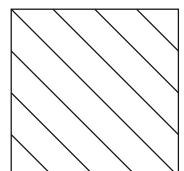

4 PIECES

SkewCut



Composition K_SW01

Composition:	100% poliester (up to 92% recycled)
Cutting method:	V-cut at 22.5 degrees
Edge:	V-cut at 22.5 degrees
Dimension:	600 x 600 mm
Thickness:	9 mm
Density:	1900 g/m ²

The panel is available in 24 colors.

The color in the visualization:



SANDY BEIGE

Sound absorption class:	PN-EN PN-EN ISO11654 $\alpha_w = 0,85$ Class B
Fire classification:	B-s2, d0 non-flammable (ITB report of the installed product)
Color scheme:	According to the S-line color chart
Mounting method:	Wall mounting - adhesive mounting
Minimum logistics:	8 panels
Unit packaging:	Cardboard box with dimensions 600 x 660 x 80 mm.

SkewCut

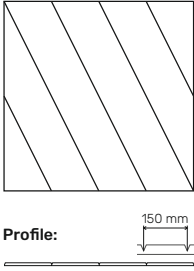
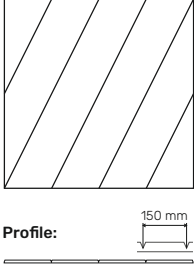
Panel	Dimensions HxWxD [mm]	Product code
 <p>Profile: 150 mm</p>	600 x 600 x 9	FD60_SkewL_SL01_L
 <p>Profile: 150 mm</p>	600 x 600 x 9	FD60_SkewL_SL02_R

Sample compositions SkewCut:

K_SWC01

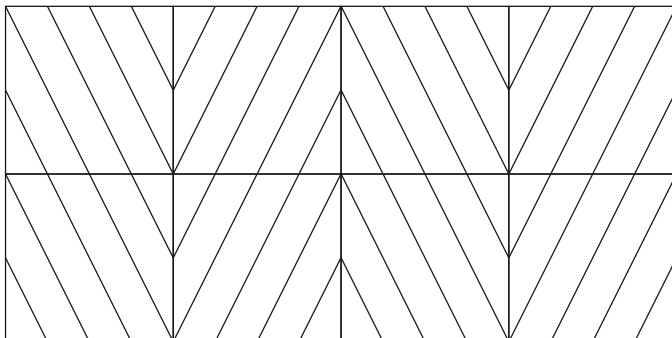

FD60_SkewL_SL01_L

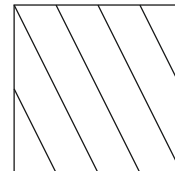

4 SZTUKI

FD60_SkewL_SL02_R

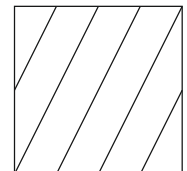

4 SZTUKI

Sample compositions **SkewCut**:

K_SWC02

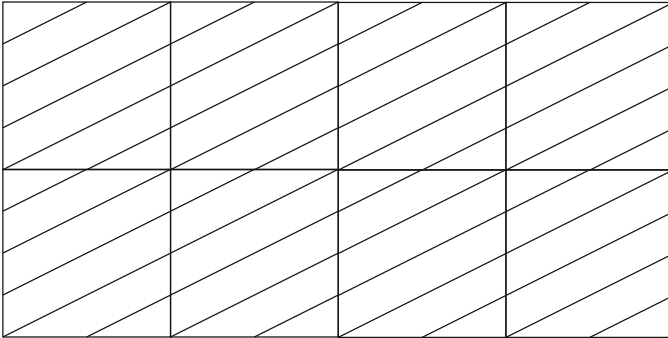

FD60_SkewL_SL01_L

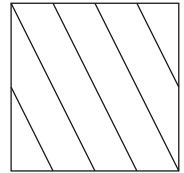

8 PIECES

K_SWC03

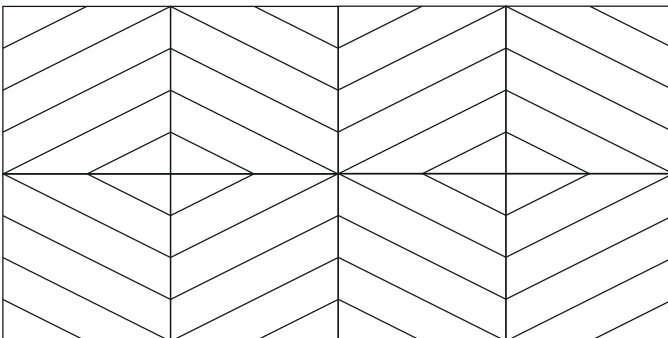

FD60_SkewL_SL01_L

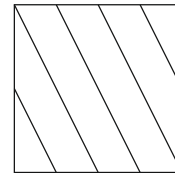

4 PIECES

FD60_SkewL_SL02_R

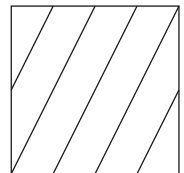

4 PIECES

K_SWC04

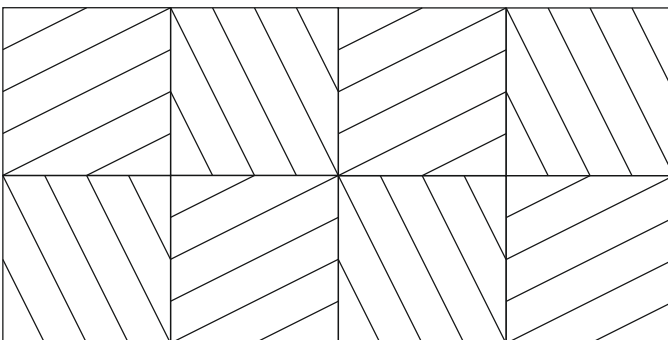

FD60_SkewL_SL01_L

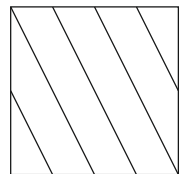

8 PIECES

Sample compositions **SkewCut**:

K_SWC05

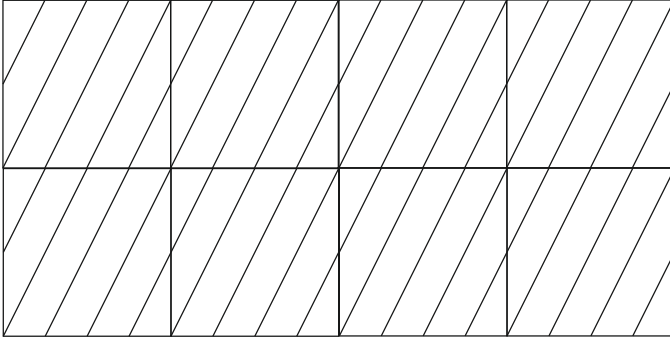

FD60_SkewL_SL02_R

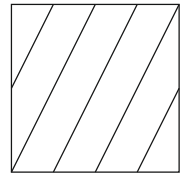

8 PIECES

K_SWC06

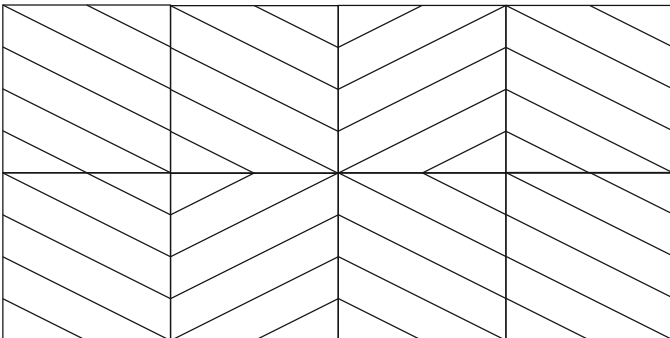

FD60_SkewL_SL01_L

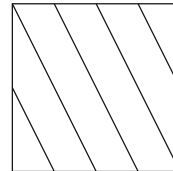

2 PIECES

FD60_SkewL_SL02_R

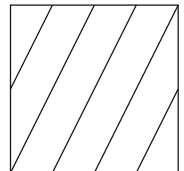

6 PIECES

K_SWC07

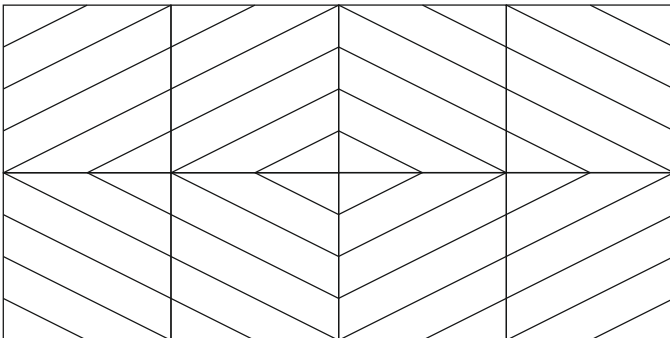

FD60_SkewL_SL01_L

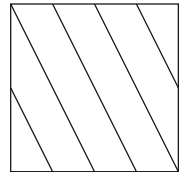

8 PIECES

FlowCut



Composition K_FC01

Composition:	100% poliester (up to 92% recycled)
Cutting method:	V-cut at 22.5 degrees
Edge:	V-cut at 22.5 degrees
Dimension:	600 x 600 mm
Thickness:	9 mm
Density:	1900 g/m ²

The panel is available in 24 colors.



The color in the visualization:



MOONSTONE GREY

Sound absorption class:	PN-EN PN-EN ISO11654 $\alpha_w = 0,85$ Class B
Fire classification:	B-s2, d0 non-flammable (ITB report of the installed product)
Color scheme:	According to the S-line color chart
Mounting method:	Wall mounting - adhesive mounting
Minimum logistics:	8 panels
Unit packaging:	Cardboard box with dimensions 600 x 660 x 80 mm.

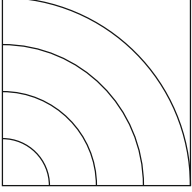
FlowCut

Panel	Dimensions HxWxD [mm]	Product code
 <p>Profile: </p>	600 x 600 x 9	FD60_FlowL_SL01_L
 <p>Profile: </p>	600 x 600 x 9	FD60_FlowL_SL02_R
 <p>Profile: </p>	600 x 600 x 9	FD60_FlowL_SL03_H
 <p>Profile: </p>	600 x 600 x 9	FD60_FlowL_SL04_C

Sample compositions **FlowCut**:

K_FC01

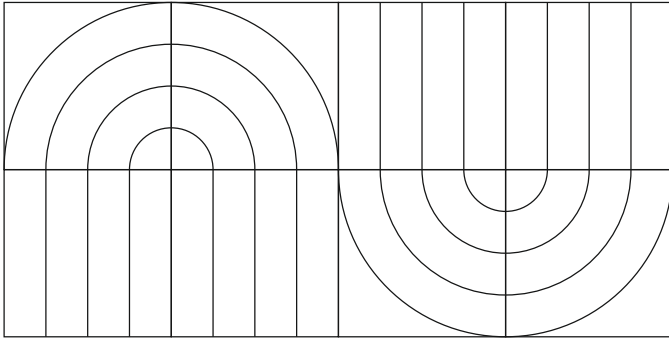

FD60_FlowL_SL02_R

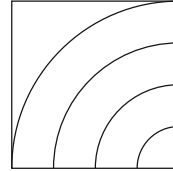

2 PIECES

FD60_FlowL_SL01_L

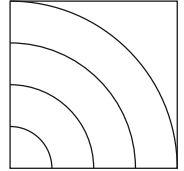

2 PIECES

FD60_FlowL_SL03_H



4 PIECES

K_FC02

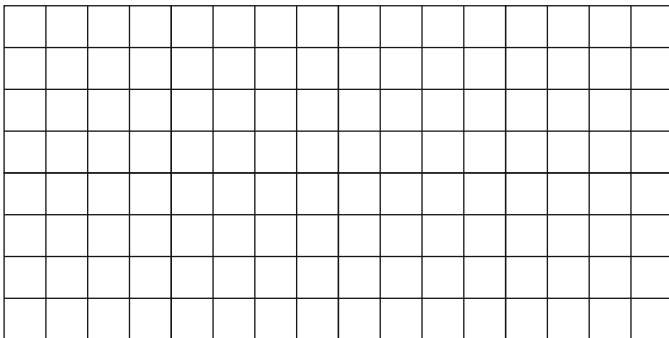

FD60_FlowL_SL04_C

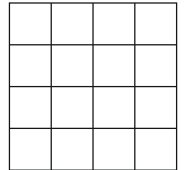

8 PIECES

K_FC03

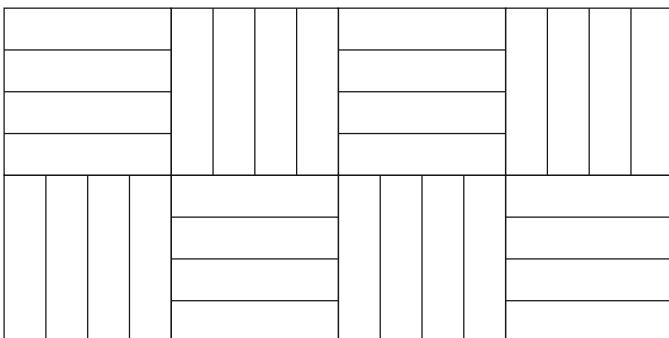

FD60_FlowL_SL03_H

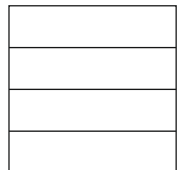

8 PIECES

Sample compositions **FlowCut**:

K_FC04

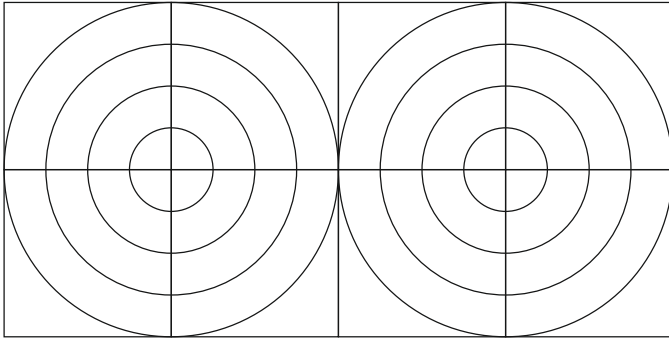

FD60_FlowL_SL02_R

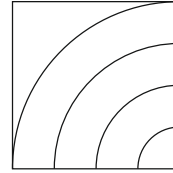

4 PIECES

FD60_FlowL_SL01_L

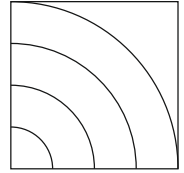

4 PIECES

K_FC05

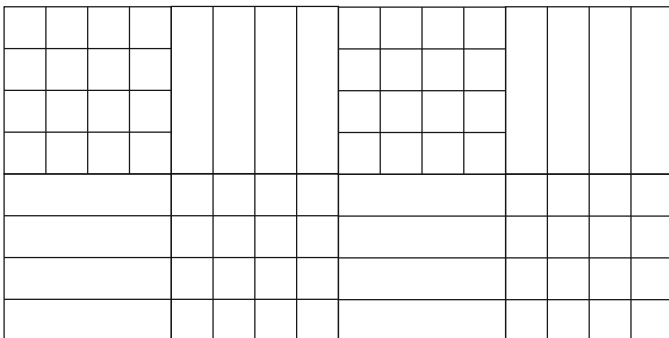

FD60_FlowL_SL03_H

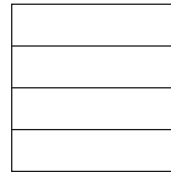

4 PIECES

FD60_FlowL_SL04_C

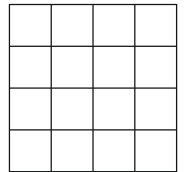

4 PIECES

K_FC06

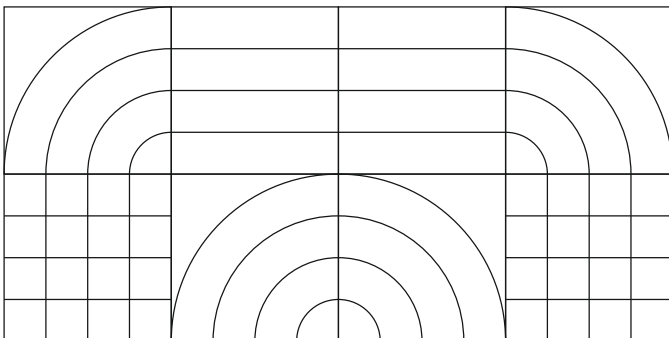

FD60_FlowL_SL04_C

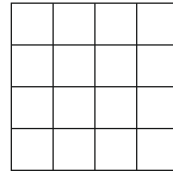

2 PIECES

FD60_FlowL_SL03_H

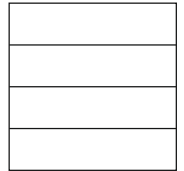

2 PIECES

FD60_FlowL_SL02_R

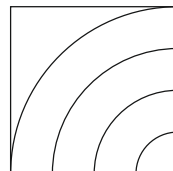

2 PIECES

FD60_FlowL_SL01_L

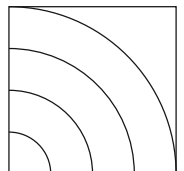

2 PIECES

Sample compositions **FlowCut**:

K_FC07

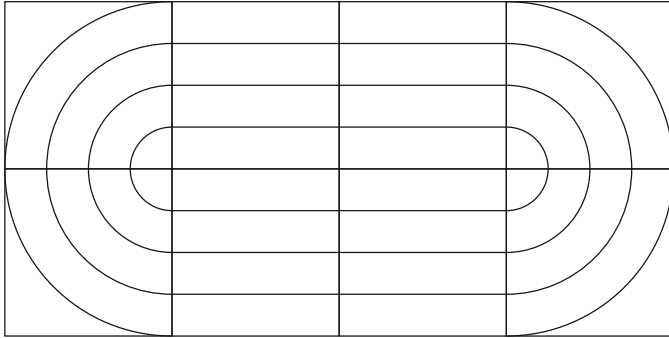

FD60_FlowL_SL01_L

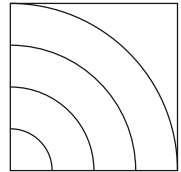

4 PIECES

FD60_FlowL_SL03_H

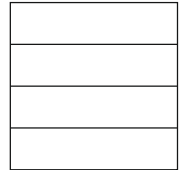

4 PIECES

K_FC08

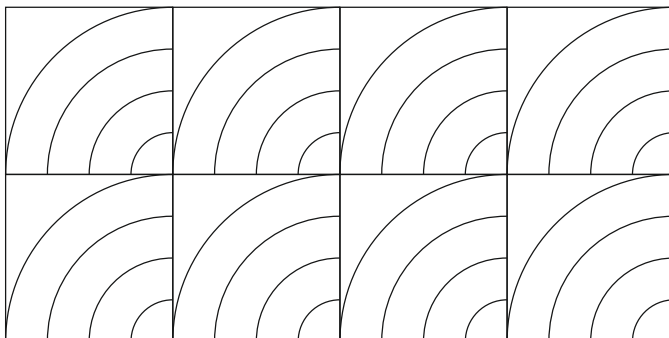

FD60_FlowL_SL02_R

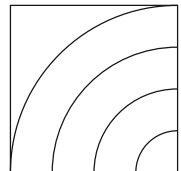

8 PIECES

K_FC09

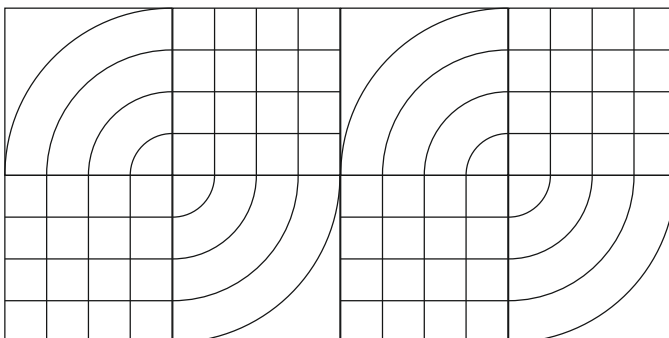

FD60_FlowL_SL02_R

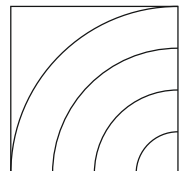

4 PIECES

FD60_FlowL_SL04_C

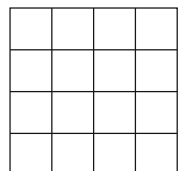

4 PIECES

BendCut



Composition K_BC01

Composition:	100% poliester (up to 92% recycled)
Cutting method:	V-cut at 22.5 degrees
Edge:	V-cut at 22.5 degrees
Dimension:	600 x 600 mm
Thickness:	9 mm
Density:	1900 g/m ²

The panel is available in 24 colors.









The color in the visualization:

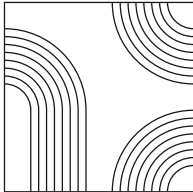

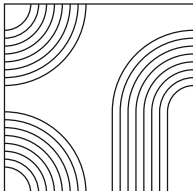
SPRING GREEN

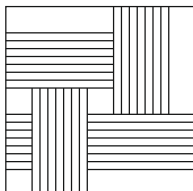
Sound absorption class:	PN-EN PN-EN ISO11654 $\alpha_w = 0,85$ Class B
Fire classification:	B-s2, d0 non-flammable (ITB report of the installed product)
Color scheme:	According to the S-line color chart
Mounting method:	Wall mounting - adhesive mounting
Minimum logistics:	8 panels
Unit packaging:	Cardboard box with dimensions 600 x 660 x 80 mm.

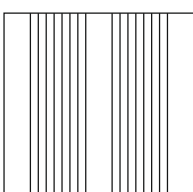
BendCut

Panel	Dimensions HxWxD [mm]	Product code
 <p>Profile: </p>	600 x 600 x 9	FD60_BendL_SL01_L
 <p>Profile: </p>	600 x 600 x 9	FD60_BendL_SL02_R
 <p>Profile: </p>	600 x 600 x 9	FD60_BendL_SL03_C
 <p>Profile: </p>	600 x 600 x 9	FD60_BendL_SL04_S

Sample compositions **BendCut**:

K_BC01

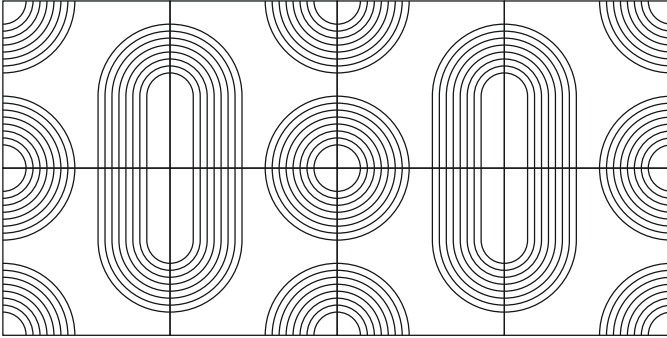

FD60_BendL_SL01_L

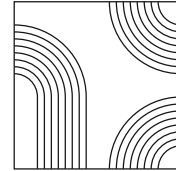

4 PIECES

FD60_BendL_SL02_R

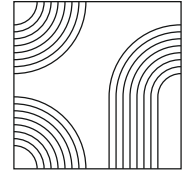

4 PIECES

K_BC02

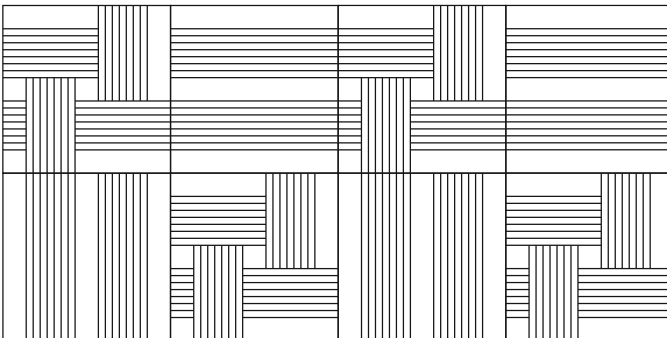

FD60_BendL_SL03_C

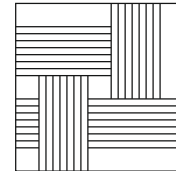

4 PIECES

FD60_BendL_SL04_S

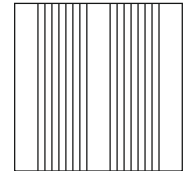

4 PIECES

K_BC03

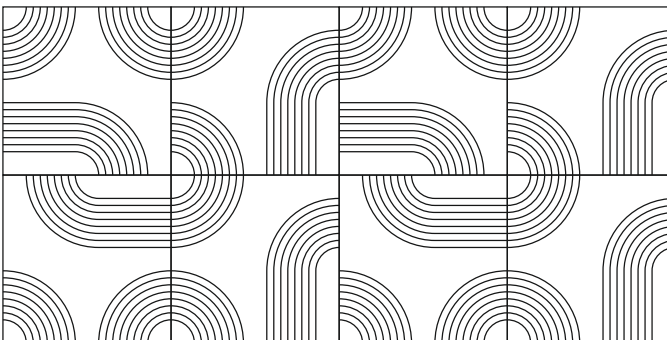

FD60_BendL_SL02_R

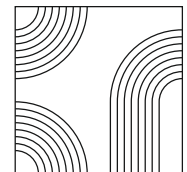

8 PIECES

Sample compositions **BendCut**:

K_BC04

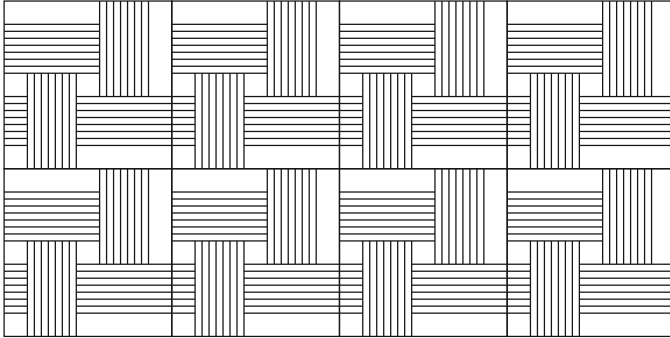

FD60_BendL_SL03_C

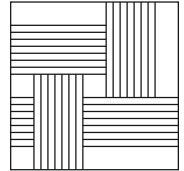

8 PIECES

K_BC05

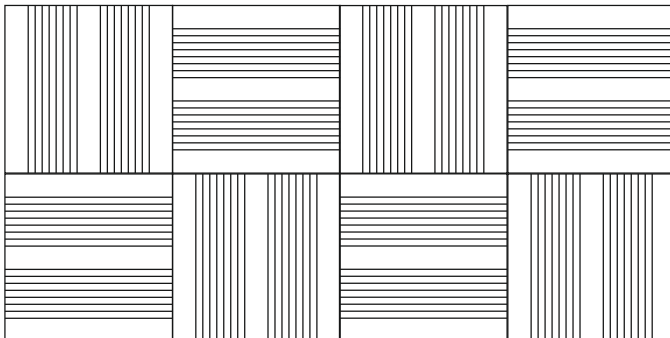

FD60_BendL_SL04_S

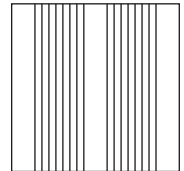

8 PIECES

K_BC06

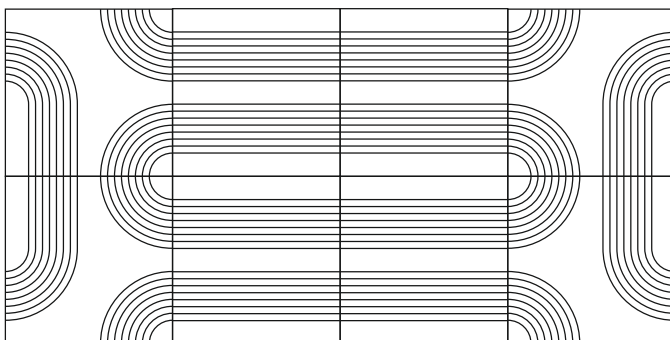

FD60_BendL_SL01_L

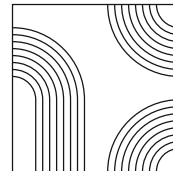

2 PIECES

FD60_BendL_SL02_R

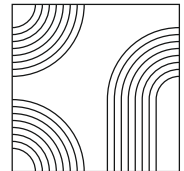

2 PIECES

FD60_BendL_SL04_S

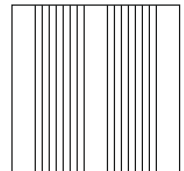

4 PIECES

Sample compositions **BendCut**:

K_BC07

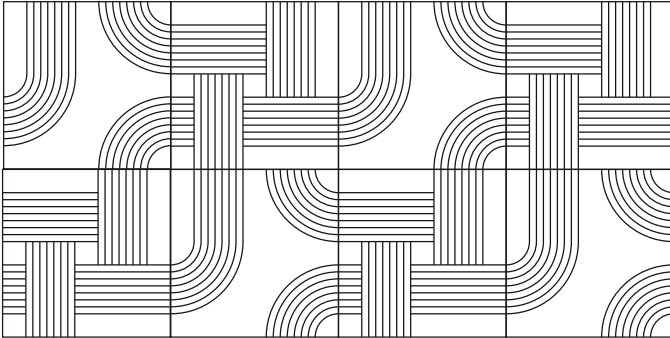

FD60_BendL_SL03_C

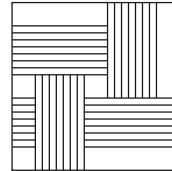

4 PIECES

FD60_BendL_SL02_R

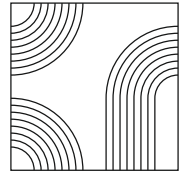

4 PIECES

K_BC08

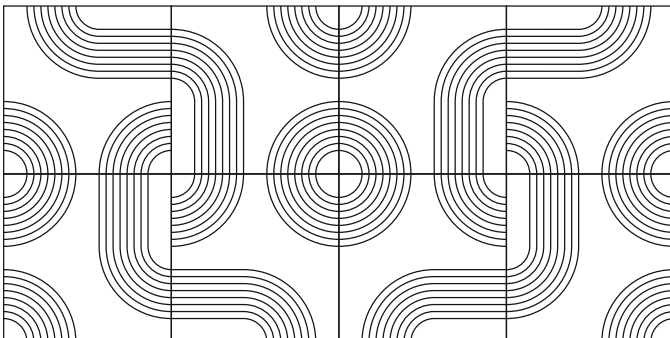

FD60_BendL_SL02_R

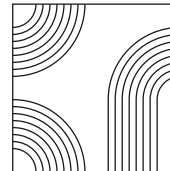

4 PIECES

FD60_BendL_SL01_L

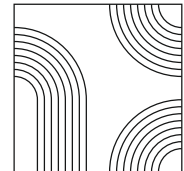

4 PIECES

K_BC09

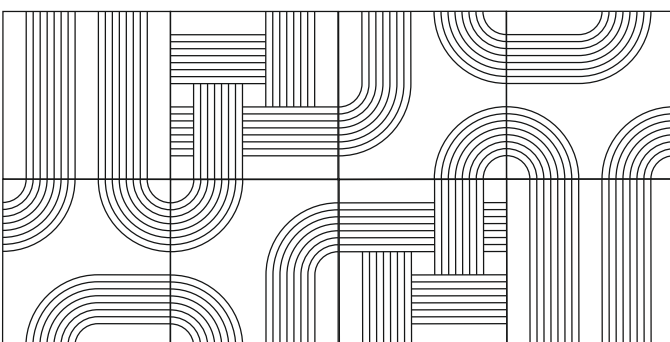

FD60_BendL_SL02_R

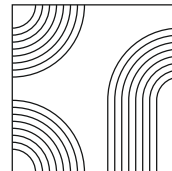

2 PIECES

FD60_BendL_SL01_L

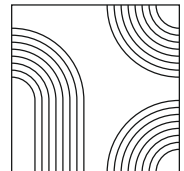

2 PIECES

FD60_BendL_SL03_C

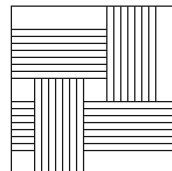

2 PIECES

FD60_BendL_SL04_S

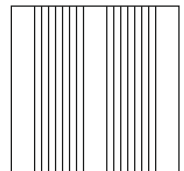

2 PIECES

CurveCut



Composition K_CEC01:

Composition:	100% poliester (up to 92% recycled)
Cutting method:	V-cut at 22.5 degrees
Edge:	V-cut at 22.5 degrees
Dimension:	600 x 600 mm
Thickness:	9 mm
Density:	1900 g/m ²



The panel is available in 24 colors.

The color in the visualization:

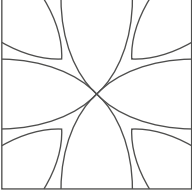

ASH GREY

Sound absorption class:	PN-EN PN-EN ISO11654 $\alpha_w = 0,85$ Class B
Fire classification:	B-s2, d0 non-flammable (ITB report of the installed product)
Color scheme:	According to the S-line color chart
Mounting method:	Wall mounting - adhesive mounting
Minimum logistics:	8 panels
Unit packaging:	Cardboard box with dimensions 600 x 660 x 80 mm.

Panel	Dimensions HxWxD [mm]	Product code
 <p>Profile:</p> 	<p>600 x 600 x 9</p>	<p>FD60_CurveL_SL01_C</p>

Sample composition **CurveCut**:

K_CEC01:

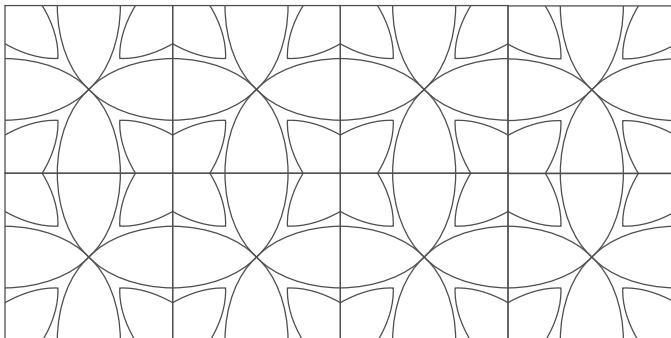

FD60_CurveL_SL01_C

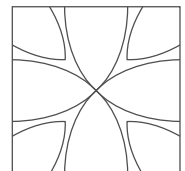

8 PIECES

color chart



WOLF GREY

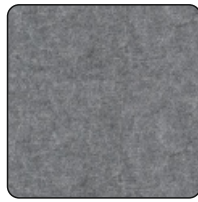

ASH GREY

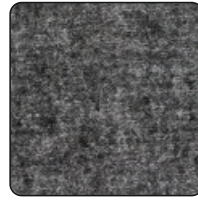

MOONSTONE GREY



RAVEN BLACK



ONYX GREY

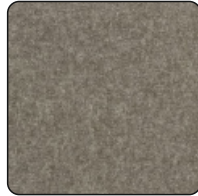

FALLOW GREY



DESERT SAND



SANDY BEIGE



BURLY WOOD



UMBER BROWN



PERU BROWN



SUNNY YELLOW

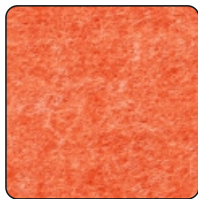

TANGERINE

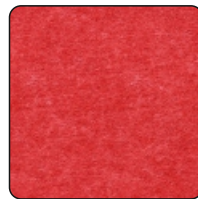

POPPY RED



CRIMSON MIST



PURPLE RAIN



GALACTIC INDIGO



DEEP SKY BLUE



AZURE BLUE



SPRING SKY

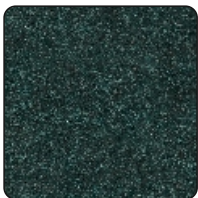

EMERALD AURORA

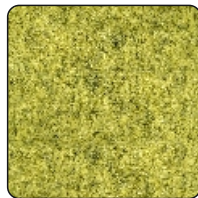

PERIDOT GREEN



SPRING GREEN



FRESH GRASS



MOONLIGHT

More than silent

* Colors on the color chart, while selected to be as close as possible to the original color shades, may vary depending on screen settings. To ensure your choice, we recommend viewing samples at the distributor's location.

price list

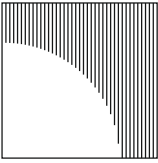
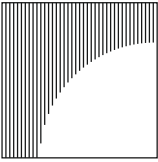
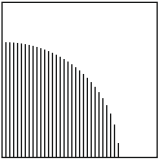
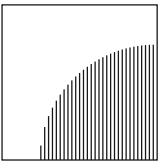
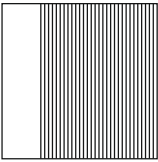
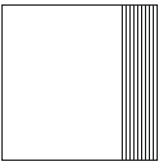
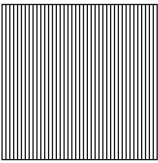
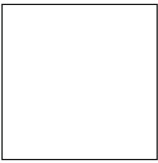
RingCut	Product code	net price/pcs
	FD60_RingL_SL01_L	€35,5
	FD60_RingL_SL02_R	€35,5
	FD60_RingL_SL03_FL	€35,5
	FD60_RingL_SL04_FR	€35,5
	FD60_RingL_SL05_AF	€35,5
	FD60_RingL_SL06_AE	€35,5
	FD60_RingL_SL07_F	€35,5
	FD60_RingL_SL08_E	€35,5
Adhesive FixALL Turbo 290 ml		€7,5

Compositions RingCut	Product code	net price/pcs
Composition 1	K_RC01	€284
Composition 2	K_RC02	€284
Composition 3	K_RC03	€284
Composition 4	K_RC04	€284
Composition 5	K_RC05	€284
Composition 6	K_RC06	€284
Composition 7	K_RC07	€284
Composition 8	K_RC08	€284
Composition 9	K_RC09	€284

*The FixALL Turbo 290 ml is not included in the price of the composition.

SlantCut	Product code	net price/pcs
	FD60_SlantL_SL01_L	€35,5
	FD60_SlantL_SL02_R	€35,5
Adhesive FixALL Turbo 290 ml		€7,5

Compositions SlantCut	Product code	net price/pcs
Composition 1	K_SC01	€284
Composition 2	K_SC02	€284
Composition 3	K_SC03	€284
Composition 4	K_SC04	€284
Composition 5	K_SC05	€284
Composition 6	K_SC06	€284
Composition 7	K_SC07	€284

*The FixALL Turbo 290 ml is not included in the price of the composition.

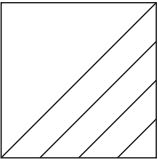
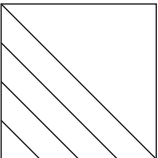
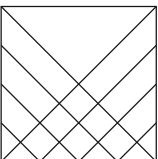
CrossCut	Product code	net price/pcs
	FD60_CrossL_SL02_R	€35,5
	FD60_CrossL_SL01_L	€35,5
	FD60_CrossL_SL03_C	€35,5
	FD60_CrossL_SL04_F	€35,5
Adhesive FixALL Turbo 290 ml		€7,5

Compositions SlantCut	Product code	net price/pcs
Composition 1	K_CC01	€284
Composition 2	K_CC02	€284
Composition 3	K_CC03	€284
Composition 4	K_CC04	€284
Composition 5	K_CC05	€284
Composition 6	K_CC06	€284
Composition 7	K_CC07	€284
Composition 8	K_CC08	€284
Composition 9	K_CC09	€284
Composition 10	K_CC010	€284
Composition 11	K_CC011	€284
Composition 12	K_CC012	€284

*The FixALL Turbo 290 ml is not included in the price of the composition.

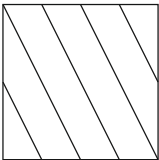
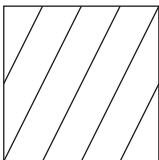
SkewCut	Product code	net price/pcs
	FD60_SkewL_SL01_L	€35,5
	FD60_SkewL_SL02_R	€35,5
Adhesive FixALL Turbo 290 ml		€7,5

Compositions SkewCut	Product code	net price/pcs
Composition 1	K_SWC01	€284
Composition 2	K_SWC02	€284
Composition 3	K_SWC03	€284
Composition 4	K_SWC04	€284
Composition 5	K_SWC05	€284
Composition 6	K_SWC06	€284
Composition 7	K_SWC07	€284

*The FixALL Turbo 290 ml is not included in the price of the composition.

FlowCut	Product code	net price/pcs
	FD60_FlowL_SL01_L	€35,5
	FD60_FlowL_SL02_R	€35,5
	FD60_FlowL_SL03_H	€35,5
	FD60_FlowL_SL04_C	€35,5
Adhesive FixALL Turbo 290 ml		€7,5

Compositions FlowCut	Product code	net price/pcs
Composition 1	K_FC01	€284
Composition 2	K_FC02	€284
Composition 3	K_FC03	€284
Composition 4	K_FC04	€284
Composition 5	K_FC05	€284
Composition 6	K_FC06	€284
Composition 7	K_FC07	€284
Composition 8	K_FC08	€284
Composition 9	K_FC09	€284

*The FixALL Turbo 290 ml is not included in the price of the composition.

BendCut	Product code	net price/pcs
	FD60_BendL_SL02_R	€35,5
	FD60_BendL_SL01_L	€35,5
	FD60_BendL_SL03_C	€35,5

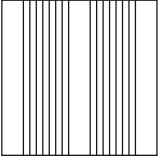
BendCut	Product code	net price/pcs
	FD60_BendL_SL04_S	€35,5
Adhesive FixALL Turbo 290 ml		€7,5

Compositions BendCut	Product code	net price/pcs
Composition 1	K_BC01	€284
Composition 2	K_BC02	€284
Composition 3	K_BC03	€284
Composition 4	K_BC04	€284
Composition 5	K_BC05	€284
Composition 6	K_BC06	€284
Composition 7	K_BC07	€284
Composition 8	K_BC08	€284
Composition 9	K_BC09	€284

*The FixALL Turbo 290 ml is not included in the price of the composition.

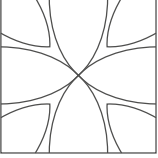
CurveCut	Product code	net price/pcs
	FD60_CurveL_SL01_C	€35,5

Compositions **CurveCut**

Composition 1	K_CEC01	€284
----------------------	---------	------

*The FixALL Turbo 290 ml is not included in the price of the composition.

Product	net price/pcs
Adhesive FixALL Turbo 290 ml	€7,5

price list valid from od 01/02/2024/4,5

Shipping

Individual packaging with dimensions of 600 x 660 x 80 mm can accommodate 8 panels and 1 unit of mounting adhesive. The estimated weight of the set is approximately 6 kg. The shipping cost is calculated individually for each country. The shipping cost for non-standard quantities of panels is always calculated individually.

Lead time

7-14 business days, depending on the availability of materials in stock.
Ask your distributor for material and color availability.

